



**Secuflow
laboratory fume cupboards**

Secuflow

Secuflow EN 7

Secuflow 

Secuflow 

WALDNER



**More safety, economy and comfort than ever:
Our Secuflow fume cupboards**

Table of contents

More safety, economy and comfort than ever: Our Secuflow fume cupboards.....2

What makes Secuflow superior: Its sophisticated flow technology.....4

Maximum work safety in the laboratory.....6

From theory to practice: Technical innovations can be measured.....8

The Secuflow requires 33% less air than conventional fume cupboards.....10

Secuflow bench-mounted fume cupboard and Secuflow low ceiling bench-mounted fume cupboard.....12

Secuflow EN7 bench-mounted fume cupboard for high thermal loads.....14

Secuflow IONIC fume cupboard – for dusty substances.....18

Secuflow Green Fume Hood (GFH) – for recirculating air operation.....22

Secuflow

The Secuflow: Satisfies highest user requirements



We are continuously working to improve laboratory equipment because being the leader in innovation is no accident.

Having developed the Secuflow further within our new range of laboratory furniture, **SCALA**, means that our Secuflow fume cupboards again fulfil highest user requirements.

Available for rear wall installation, with new design widths and a larger internal workspace, investing into Secuflow returns significant advantages:

We have now reduced our fume cupboards' energy consumption even further. Equipped with optimised supply and extract air ducts, the Secuflow requires an extract air volume of only 270m³/h/lfm while operating safely.

This significantly reduced energy consumption makes laboratory operations even more economical.

Modifications of details such as the control panel which is inclined towards the user, the new lock on the sash, the 2-chamber flow technology, the flow-in

duct between the sash frames and the side post profile, the Soft Touch control panel, the sink modules integrated into the rear panel of the fume cupboard, as well as many other design features ensure safe and comfortable working.

Find out why the Secuflow sets the standard for the future.

WALDNER



What makes Secuflow superior: Its sophisticated flow technology

Because we are constantly further developing our company and our products, we are leading the market in the field of laboratory furniture and fume cupboards. To achieve this, we combine our engineering know-how with scientific findings in flow technology.

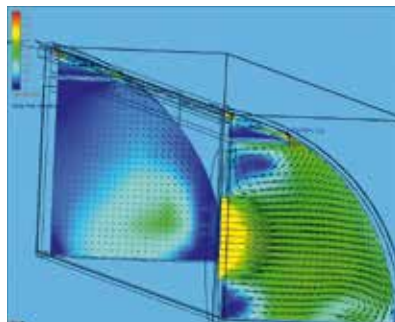
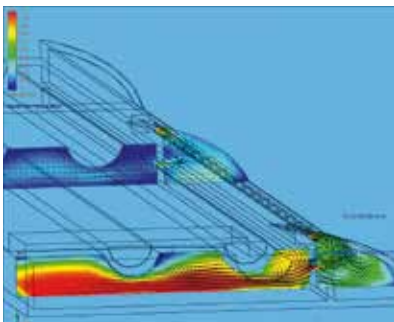

The result is our highly innovative Secuflow with supportive flow technology for optimum flow regulation.

With the Secuflow, supportive air is systematically directed into the internal workspace from the aerodynamically designed sill on the side panel and along the worktop. This prevents turbulences and perfectly stabilises the inflow air.

Extraction is performed safely on the rear panel of the fume cupboard shortly above the worktop, and around the service panels and the fume cupboard top panel.

Secuflow

The Secuflow: Where construction and science go hand in hand

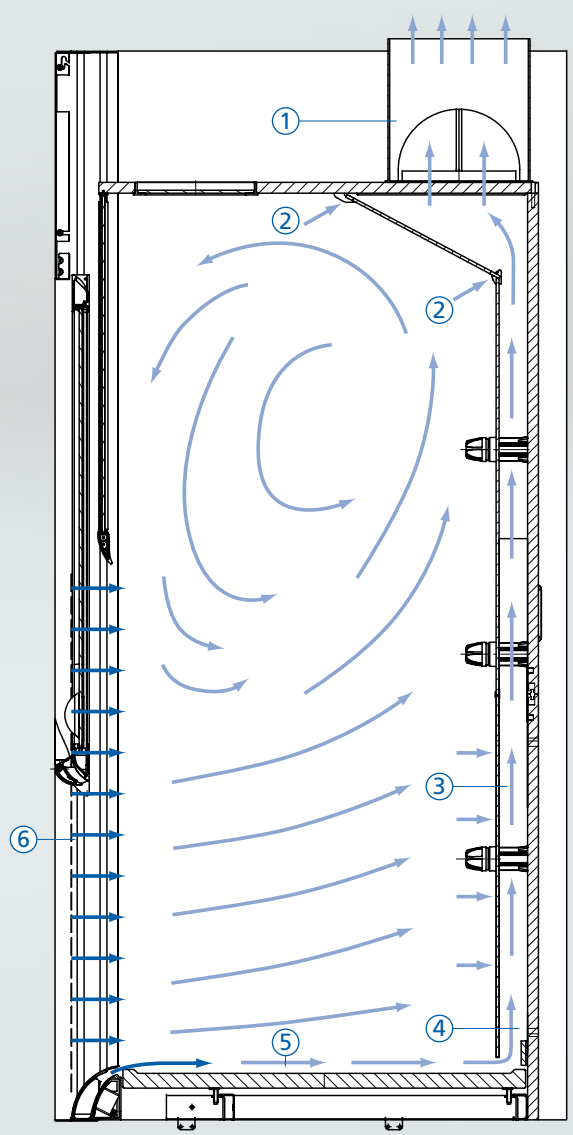

EN 14175 has defined significantly stricter criteria for flow technology in fume cupboards. In particular, the new robustness test defines high requirements for the containment values of fume cupboards. Due to the optimised flow in our new fume cupboards, now even less extract air is necessary to ensure safe operation.

Secuflow takes you one step ahead in laboratory fume cupboard technology.



- ① Extract manifold
- ② Inclined extract fume cupboard top panel
- ③ Extract service panels in baffle
- ④ Baffle
- ⑤ Supportive flow technology over entire width of worktop
- ⑥ Supportive flow technology along both side posts

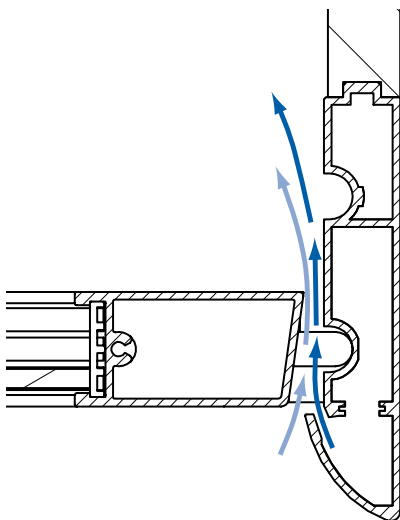

Cross section through sash and side post.
 Due to the special design, ambient air is flowing in like being accelerated through a nozzle without jeopardising the splash protection.





Maximum work safety in the laboratory

Operating laboratory fume cupboards with the sash closed only is not always possible during everyday laboratory work. It is often necessary to modify experimental setups or processes inside the fume cupboard.

Turbulences which can create outbreaks from inside the workspace can occur when opening the sash, if the sash is open, or when working in the internal workspace.

Complex experimental setups or people walking past the fume cupboard will intensify this outbreak effect into the laboratory, thus endangering staff working with the fume cupboard.

This is why EN 14175 now places even more emphasis on the containment factor of fume cupboards when the sash is open.

The containment values in conventional standard fume cupboards can primarily be reduced by increasing the extract air volume. This results in an increased energy consumption and higher noise levels.

Secuflow

The Secuflow: Optimum values for laboratory staff



The new Secuflow offers even more safety and requires less energy. When the internal workspace is extensively equipped or a lot of movement is taking place in front of the fume cupboard, the Secuflow still shows excellent containment values – even when the sash is open. And all this is achieved with reduced extract air volumes and, as a consequence, a significantly lower energy consumption.

In extensive test series, we have defined the new standard that again surpasses the requirements of EN 14175 and ASHRAE 110, which sets the standard for the future. For maximum safety at work.



The lock on the sash can easily be operated with one hand

Operation panel for displaying safety relevant data.



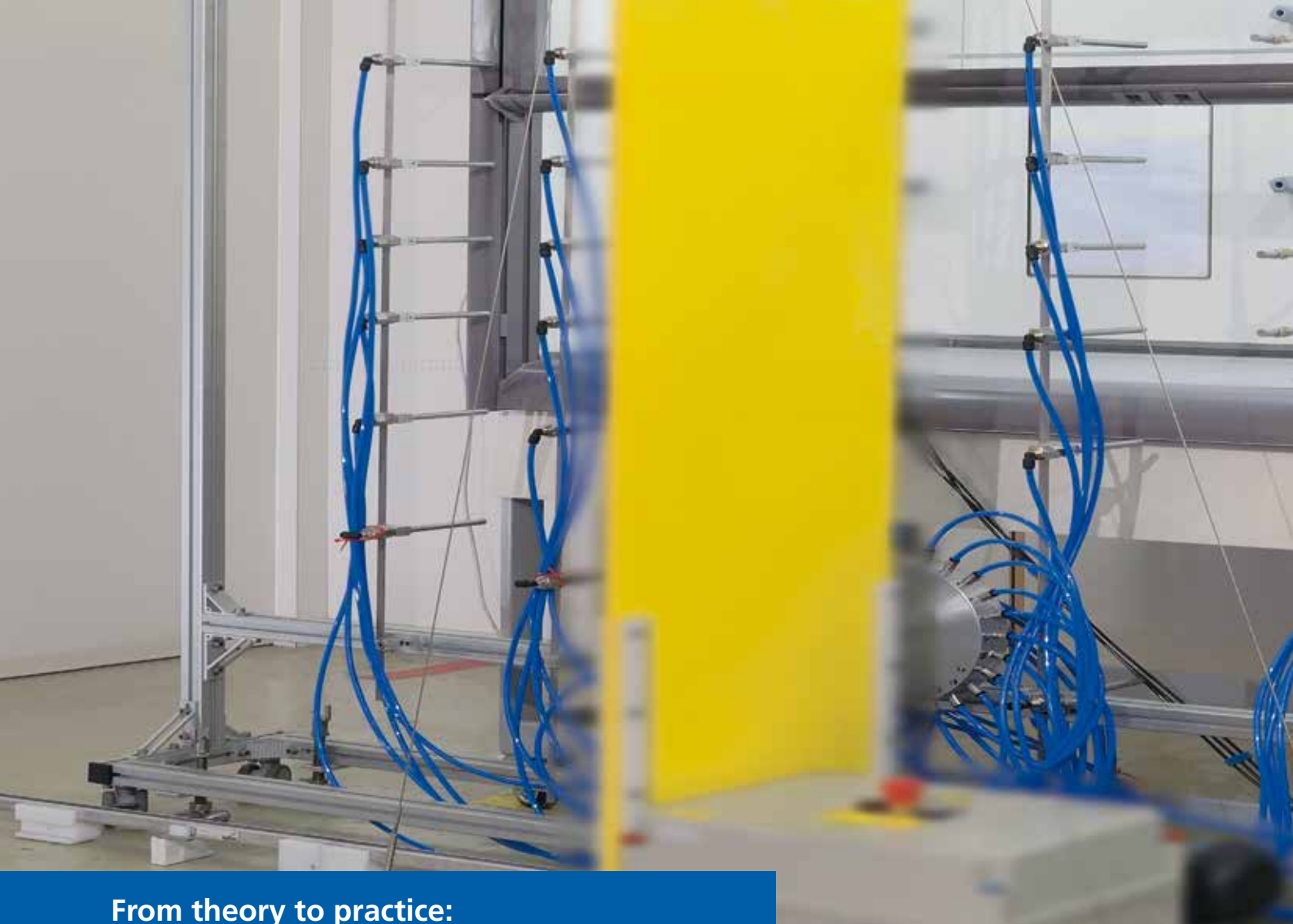

From theory to practice: Technical innovations can be measured

The Secuflow had to pass a considerable number of tests in all development stages.

The aerodynamically optimal component design was carefully determined, as was the ergonomic functionality of the supply connections or modular installation elements.

With the new profile of the worktop edge, the cleverly designed extract air distribution in the fume cupboard as well as the stable circulation around the side posts we have been able to reduce the extract air volume in our fume cupboards even further while guaranteeing safe operation at all times.

The airflow of the supportive flow technology in the area of the sash opening is perfectly matched to the entire extractor distribution on the rear panel and the internal workspace.

All physical influences on aerodynamically relevant areas of the fume cupboard were tested and noise was reduced even further in the new Secuflow fume cupboards. We achieved the lowest possible values under a wide range of different operating conditions.

Secuflow

The Secuflow: Optimum values in every operating state



The result of our work is a perfectly coherent product which has passed all final EN 14175 and ASHRAE 110 tests with excellent results.

Beyond the requirements of EN 14175, we also performed the tests for an opening height of 900 mm. Here, too, the new Secuflow convinces with its outstanding test results for the benefit of user safety.

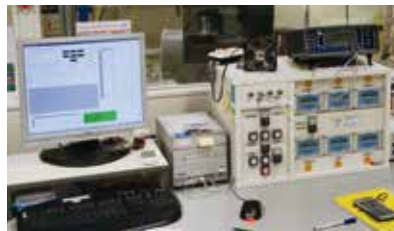



The Secuflow requires 33% less air than conventional fume cupboards

During laboratory operation, a standard fume cupboard consumes about the same amount of energy per year as a family home.

So it is not surprising that the ventilation of the laboratory building accounts for the main part of laboratory operating costs. The flow rate of conditioned supply air and the dimensioning of the ventilation system clearly depend on the fume cupboards used.

At $270\text{m}^3/\text{h}/\text{lfm}$, Secuflow fume cupboards (except of EN7 and GFH) easily fall below the maximum values for tracer gas specified in German regulations (BG RCI) and numerous other countries across the world. Conventional fume cupboards require at least $400\text{m}^3/\text{h}/\text{lfm}$ for this.

In this way, the Secuflow reduces the air volume by 33% compared with conventional fume cupboards. This means significant savings not only in energy costs and investment costs for the ventilation system, but also in the dimensioning of the entire building.

Investing in the Secuflow will quickly pay for itself. Make use of the advantages of the Secuflow for your laboratory of the future.

Secuflow

The Secuflow: Investing into the laboratory of the future

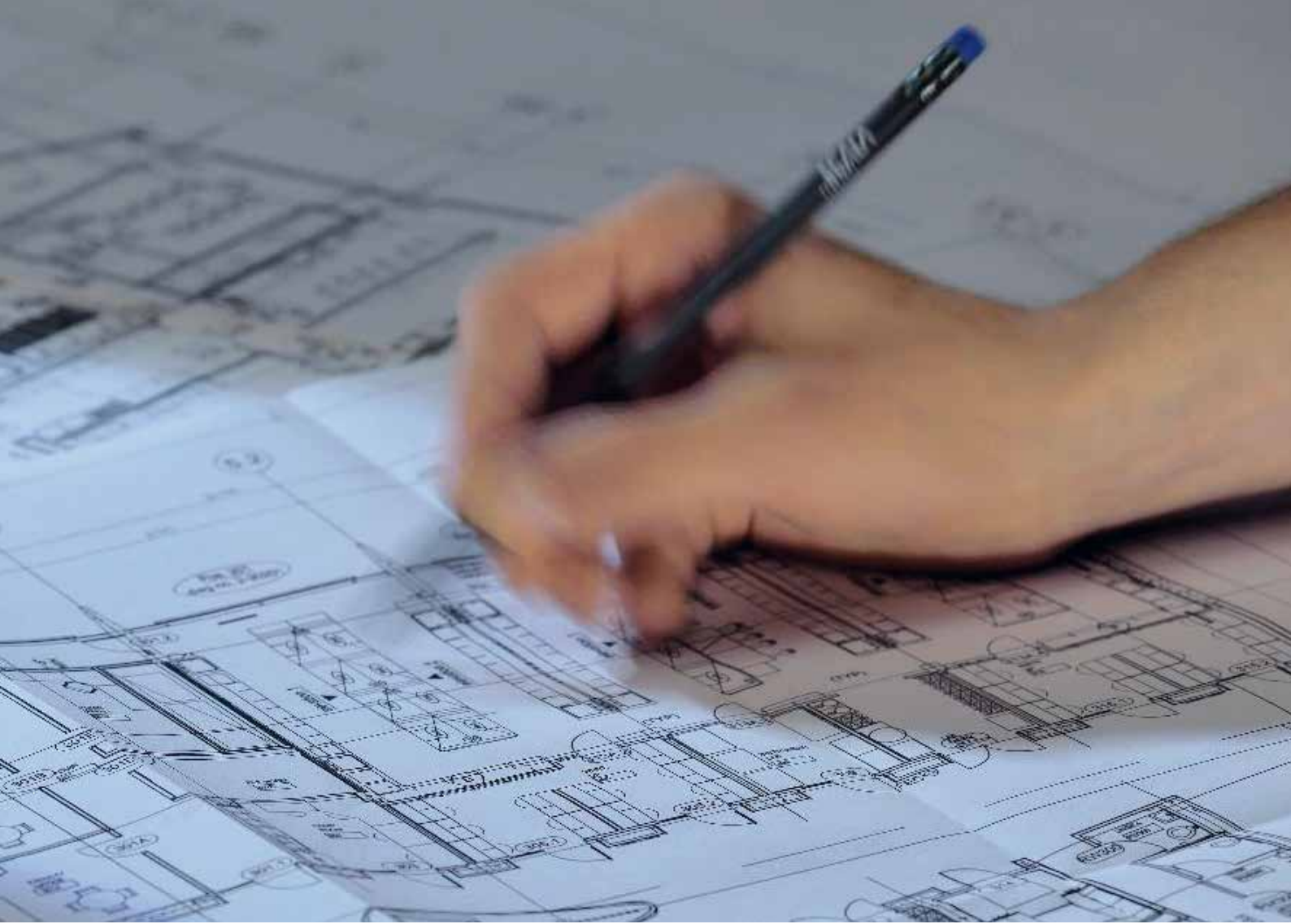

We will be happy to calculate the potential savings for your specific laboratory project through Secuflow fume cupboards.

In addition, we are the only manufacturer who offers you fume cupboards and controls all from one supplier. Benefit from our know-how. We will be glad to help you.

For more information about Waldner laboratory control, please see our special brochure or visit us at www.waldner-lab.com.



WALDNER

Secuflow bench-mounted fume cupboard and Secuflow low ceiling bench-mounted fume cupboard

Energy efficiency, perfect ergonomics and a larger internal workspace make working with our new fume cupboards even safer and more convenient.

A new design together with an enlarged product range characterises the fume cupboards of our new **SCALA** laboratory range.

Combined with grid widths up to 2100 mm of our fume cupboards, we offer the most comprehensive product range available in the market.

Largest usable internal workspace

The slender, patented side posts of our fume cupboards offer an increased clear width of the internal workspace of the fume cupboard. The internal workspace is 10 % higher, making it larger altogether. This is useful when working with tall and wide items of experimental equipment.

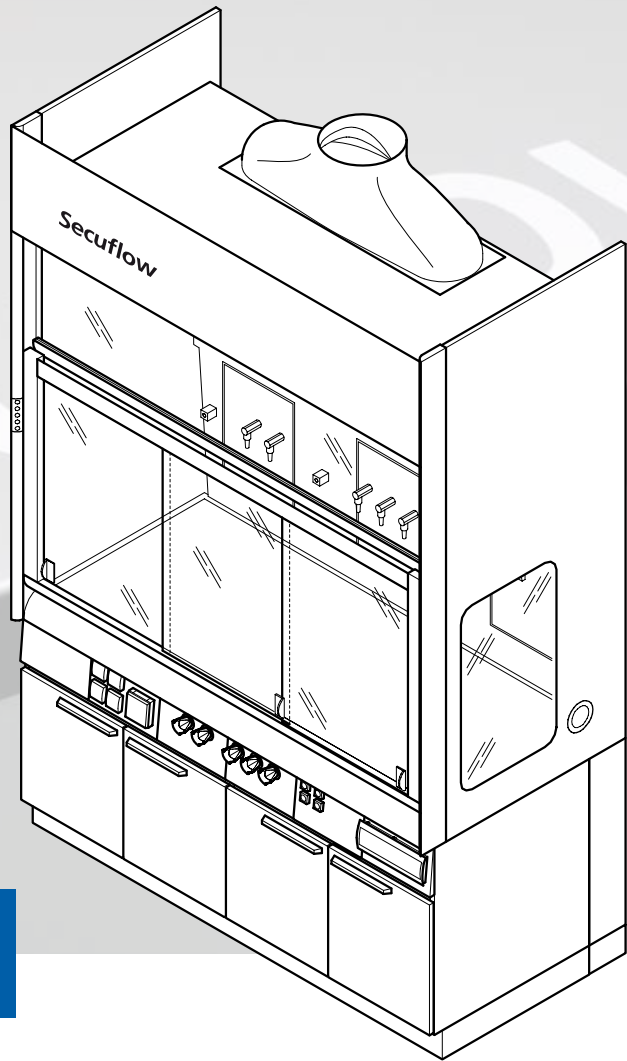

Secuflow bench-mounted fume cupboards

Intended use

- Protective device for the user, tested in acc. with EN 14175
- Extraction of fumes, aerosols and dust from the internal workspace to prevent dangerous amounts of pollutants from escaping into the laboratory
- Reduced risk of the formation of a high concentration of hazardous substances / hazardous explosive atmosphere in the internal workspace
- Protection from splashes of hazardous substances
- Protection from flying particles, bodies or parts escaping from the internal workspace
- General purpose fume cupboards constructed in acc. with EN 14175 are normally not suited for use with radioactive substances or microorganisms
- Not suitable for the process of breaking down chemicals
- Active supportive flow technology (Secuflow technology) reduces the energy consumption while regulations and standards are observed
- Service outlets in the rear panel of the internal workspace
- Control units located externally at the support
- Only low ceiling bench-mounted fume cupboards: Suitable for rooms with a low height

Secuflow

Technical data

Dimensions	1200	1500	1800	2100
Width [mm]	1200	1500	1800	2100
Depth [mm]	900			
Height [mm]	2700			
Height [mm] Low ceiling fume cupboard	2400			
Clear width of internal workspace [mm]	1150	1450	1750	2050
Clear height of internal workspace [mm]	1550			
Clear height of internal workspace [mm] Low ceiling fume cupboard	1250			
Working height [mm]	900			

Weight	1200	1500	1800	2100
Without installation [kg]	Approx. 250	Approx. 300	Approx. 350	Approx. 400
Without installation [kg] Low ceiling fume cupboard	Approx. 220	Approx. 260	Approx. 300	Approx. 350

Design characteristics	1200	1500	1800	2100
Supporting construction	Self-supporting underbench units or H-frame with push-in underbench units			
Sash	2 horizontal sashes		3 horizontal sashes	
Side panel of the fume cupboard	Glass pane on the left and/or right as an option; not with stoneware internal lining Material lock on the left and/or right as an option			
Max. number of devices for scaffold points, \varnothing 12 mm to 13 mm	9		12	
Max. load per scaffold point with scaffold rod length 300 mm [kg]	5			
Service modules	2		3	

Electrics	
Electrical supply	External sockets in service panels Internal sockets in service modules
Fuse box	Optional
Sash controller SC	Optional

Sanitary technology	
Sanitary supply	Service modules with take-off valves for vacuum, gases and/or waters and integrated sink (PP) as an option

Material/surface	
Worktop	Stoneware , Polypropylene, Stainless steel, Epoxy
Internal lining	Melamine resin facing, Solid grade laminate, Stoneware

Ventilation technology	1200	1500	1800	2100
Minimum air exchange rate [m^3/h] ¹⁾	330	410	490	570
Function display	FAZ			
Airflow damper, constant / variable	Airflow-Controller AC			
Detector of sash position	Only variable with Airflow-Controller AC			
Connection height [mm] for FAZ with extract manifold \varnothing 250 mm	2720			
Connection height [mm] for FAZ with extract manifold \varnothing 250 mm Low ceiling fume cupboard	2420			
Connection height [mm] for FAZ with extract manifold \varnothing 315 mm ²⁾	2850			
Connection height [mm] for FAZ with extract manifold \varnothing 315 mm ²⁾ Low ceiling fume cupboard	2550			
Connection height [mm] for AC with extract manifold \varnothing 250 mm	2950			
Connection height [mm] for AC with extract manifold \varnothing 250 mm Low ceiling fume cupboard	2650			
Connection height [mm] for AC with extract manifold \varnothing 315 mm ²⁾	3070			
Connection height [mm] for AC with extract manifold \varnothing 315 mm ²⁾ Low ceiling fume cupboard	2770			
Underbench exhaust	As an option, depending on requirements and regulations			

¹⁾ All air volume specifications refer to an opening height of the sash window of 500 mm (test opening in acc. with EN 14175) and the maximum tracer gas values recommended by German Standard (BG RCI). Shown rates correspond to a face velocity of 0.15 m/s. For other design face velocities, please contact your Waldner sales representative.

²⁾ In order to minimise noise and pressure losses, for air volumes $>1000 \text{ m}^3/\text{h}$ Waldner recommends using the extract manifold with a connection diameter of 315 mm.

A maximum admission pressure of 600 Pa should not be exceeded in the case of fume cupboards with airflow dampers. The indicated minimum air exchange rates were determined under specified test conditions in acc. with EN 14175-3. These minimum air exchange rates must be adapted when dimensioning the ventilation system.

If on-site extract air monitoring systems or airflow dampers are used, the required air volumes may be different.

The operating limitations must be agreed upon with Waldner.





Secuflow EN7 bench-mounted fume cupboard for high thermal loads

We are a leading supplier in the field of laboratory equipment and laboratory fume cupboards because we are constantly developing ourselves and our products. To achieve this, we combine our constructive know-how with the results of systematic investigation and testing of the flow technology of laboratory fume cupboards. Energy efficiency and optimum ergonomics make our fume cupboards safe and comfortable for the people working with them.

For years now, we have been introducing our expert-ise in laboratory design and construction to standard-isation committees in order to improve the safety in laboratories even further. In our own certified testing laboratory, we test our fume cupboards in accordance with EN 14175 – Part 3, 4, 6 and 7.

We have always been searching for solutions that will make our fume cupboards even safer and more energy efficient. The energy consumption is extremely low, whilst high safety standards are maintained, due to the continual optimisation of our flow technology.

The standard EN 14175-7:2012 regulates fume cupboards for special application with high thermal load and/or acidic load. The use of these special purpose fume cupboards instead of general purpose fume cupboards is usually the result of a risk assessment.

The standard is applicable for the following special purpose fume cupboards:

- **Fume cupboards for high thermal loads**
- Fume cupboards for high thermal loads in combination with acid digestions
- Fume cupboards for handling of perchloric acid
- Fume cupboards for handling of hydrofluoric acid

Secuflow EN



Standard fume cupboard with heating source



Secuflow EN7 with heating source

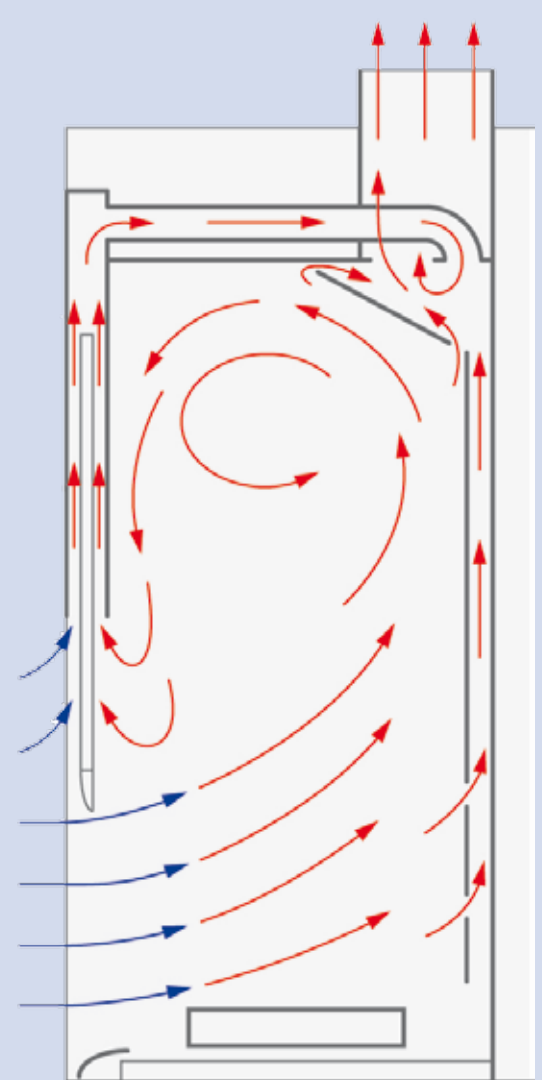

Flow pattern in the Secuflow EN7 with heating source

Additional objectives that are formulated in section 7 go beyond the safety and performance targets defined in EN 14175-2, for example:

Requirements for materials

In fume cupboards for high thermal loads, the materials used must be able to meet the resulting demands. The materials must be chemically resistant to acids and acidic vapours and resistant to thermal deformation at the working temperatures.

Requirements on the cleanability

The construction of the fume cupboard must secure the necessary access to all air flow parts for cleaning purposes.

Requirements on the air flow and the monitoring

Impacts on the air current, caused by thermal loads and installed heating appliances, for example, must be taken into account and limited.

In addition to the fume cupboard function display with the acoustic and optical alarm, fume cupboards for high thermal loads must be equipped with a temperature sensor that will trigger an alarm when the maximum temperature is reached.

While the previous standard series EN 14175 defines exclusively isothermal conditions in the fume cupboard, the newly issued part 7 offers the opportunity to evaluate the safety of fume cupboards on incidence of high thermal loads. This closes a significant gap, as working with heat sources in the fume cupboard is part of the everyday routine work in many laboratories.

Secuflow EN7 bench-mounted fume cupboard

The Secuflow is especially successful because it can be operated with lower extract air volumes, which means considerable saving in energy costs and in the investment costs for the ventilation system. The Secuflow is the safest and most ecologically sound variant.

We have developed the Secuflow EN7 to secure these benefits also for working with high thermal loads. Due to its sophisticated supply and extract air flow, the fume cupboard secures safe operation when working with thermal loads, whilst retaining all the benefits of the supportive flow fume cupboard Secuflow.

When the laboratory is equipped with Secuflow EN7 fume cupboards, the user is ideally equipped for any kind of laboratory work: whether this is normal operation or working with thermal loads.

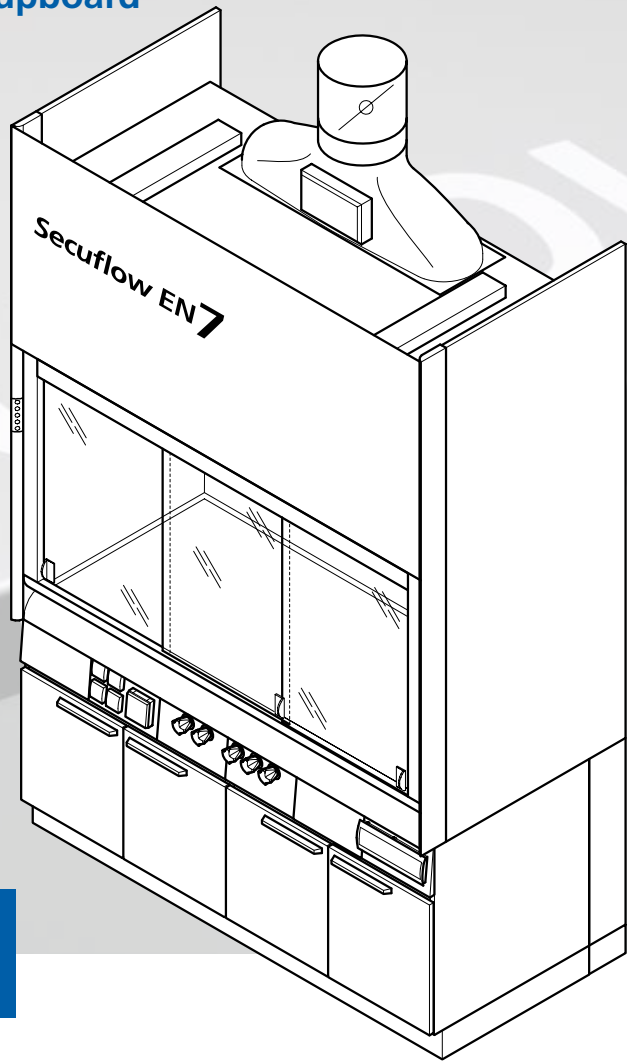

Secuflow EN7 bench-mounted fume cupboard for high thermal loads

Intended use

- For work with high thermal loads in the inside of the fume cupboard (Heat sources of 4 KW per meter inner width of the cupboard)
- Protective device for the user, tested in accordance with EN 14175-7:2012
- Extraction of fumes, aerosols and dust from the internal workspace to prevent dangerous amounts of pollutants from escaping into the laboratory
- Reduced risk of the formation of a high concentration of hazardous substances / hazardous explosive atmosphere in the internal workspace
- Protection from splashes of hazardous substances
- Protection from flying particles, bodies or parts escaping from the internal workspace
- General purpose fume cupboards constructed in acc. with EN 14175 are normally not suited for use with radioactive substances or microorganisms
- Not suitable for openly breaking down chemicals
- Active supportive flow technology (Secuflow technology) reduces the energy consumption while regulations and standards are observed
- Service outlets for sanitary supply in the rear panel of the internal workspace
- Control units located horizontally on the service rail of the support unit

Secuflow EN

Technical data

Dimensions	1200	1500	1800
Width [mm]	1200	1500	1800
Depth [mm]		900	
Height [mm]		2700	
Clear width, internal workspace [mm]	1150	1450	1750
Clear height, internal workspace [mm]		1550	
Working height [mm]		900	

Design characteristics	1200	1500	1800
Supporting construction	Self-supporting underbench units or H-frame with push-in underbench units		
Sash	2 horizontal sashes		3 horizontal sashes
Max. number of devices for scaffold points, \varnothing 12 mm to 13 mm	9		12
Service modules	2		3

Electrics	
Electrical supply	External sockets in service panels
Fuse box, Sash controller SC	Optional

Sanitary technology	
Sanitary supply	Service modules with take-off valves for vacuum, gases and/or waters and integrated sink (PP) as an option

Material/surface	
Worktop	Stoneware, Polypropylene, Stainless steel, Epoxy
Internal lining	Melamine resin facing, Solid grade laminate, Stoneware

Ventilation technology	1200	1500	1800
Air flow range without / with thermal load [m^3/h] ¹⁾	450 / 700	450 / 750	540 / 900
Airflow damper, variable, including detector of sash position	Airflow-Controller AC		
Function display with temperature monitoring	FAZ		
Connection height [mm] for FAZ with extract manifold dia. 250 mm	2720		
Connection height [mm] for AC with extract manifold dia. 250 mm	2950		
Underbench exhaust	As an option, depending on requirements and regulations		

¹⁾ All air volume specifications refer to an opening height of the sash window of 500 mm (test opening in acc. with EN 14175) and the maximum tracer gas values recommended by German Standard (BG RC1).

A maximum admission pressure of 600 Pa should not be exceeded in the case of fume cupboards with airflow dampers. The indicated minimum air exchange rates were determined under specified test conditions in acc. with EN 14175-3. These minimum air exchange rates must be adapted when dimensioning the ventilation system.

If on-site extract air monitoring systems or airflow dampers are used, the required air volumes may be different. The operating limitations must be agreed upon with Waldner.



Secuflow IONIC fume cupboard – for dusty substances

Based on our successful Secuflow fume cupboard the ionization unit IONIC is an additional feature which demonstrably increases the safety when handling dusts. All functions and operation methods of the Secuflow fume cupboard are fully available according to DIN EN 14175.

To illustrate this, a SMEPAC test was performed on a Secuflow Ionic width 1500.

Challenge

Air-borne dusts, particles with sizes of up to 1 µm, usually behave in the flow of a fume cupboard like gas. However, wall areas are an exception. Dusts adhere to the sides due to electrostatic sticking or repulsive effects. Adhesive dusts, which cannot be removed by wiping or ordinary cleaning, increase the likelihood of harmful emissions and therefore present an increased risk for laboratory workers.

Secuflow *IONIC*

The fume cupboard with ionisation technology



Ionisation technology

We have evolved the Secuflow supportive flow technology in our Secuflow ionic fume cupboard. To achieve this, ionisation electrodes have been integrated in the worktop and in the side posts close to the supportive flow outlets of the Secuflow Ionic. As a result, the generated ions are directed backward with the supportive flow and the surfaces are discharged. The adhesion of harmful dusts in the critical areas, the worktop and the side posts, as well as a possible outbreak of harmful substances is prevented.



Ionisation electrodes of the supportive air flow

Secuflow IONIC fume cupboard

Active method of discharge:

The ionization of the supportive air flow gives rise to an equally large number of positively and negatively charged ions. These ensure the discharge of static charged surfaces in the fume cupboard interior.

The supportive air flow is ionized by the high voltage applied to the tips in the electrodes.

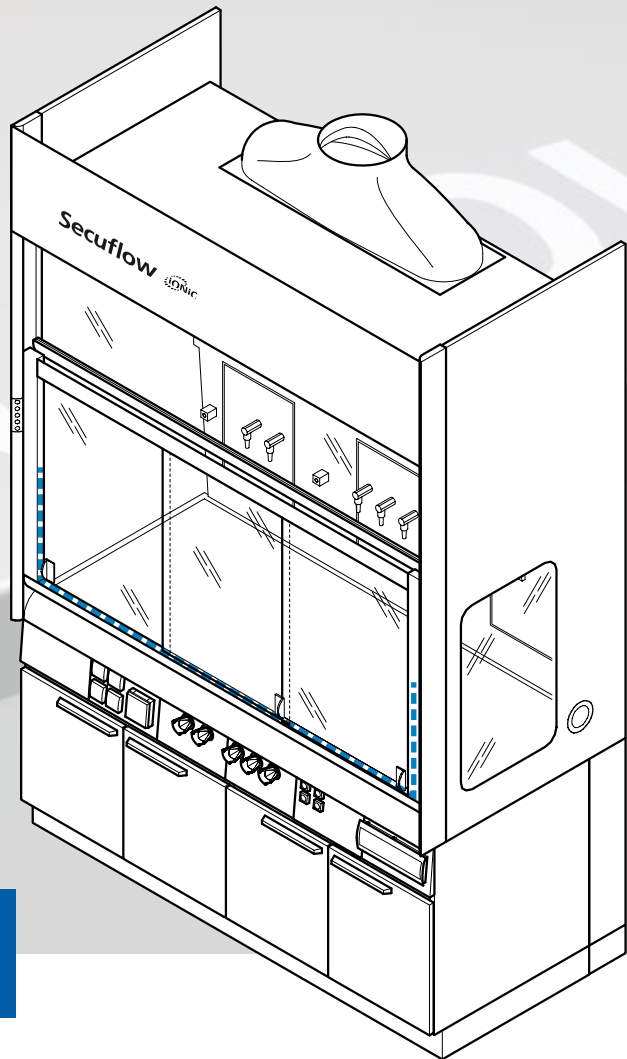

Secuflow IONIC fume cupboard – for dusty substances

Intended use

- Protective device for the user, tested in acc. with EN 14175
- Extraction of fumes, aerosols and dust from the internal workspace to prevent dangerous amounts of pollutants from escaping into the laboratory
- Reduced risk of the formation of a high concentration of hazardous substances / hazardous explosive atmosphere in the internal workspace
- Protection from splashes of hazardous substances
- Protection from flying particles, bodies or parts escaping from the internal workspace
- General purpose fume cupboards constructed in acc. with EN 14175 are normally not suited for use with radioactive substances or microorganisms
- Not suitable for the process of breaking down chemicals
- Active supportive flow technology (Secuflow technology) reduces the energy consumption while regulations and standards are observed
- Service outlets in the rear panel of the internal workspace
- Control units located externally at the support

Secuflow *IONIC*

The fume cupboard with ionisation technology

Technical data

Dimensions	1200	1500	1800
Width [mm]	1200	1500	1800
Depth [mm]	900		
Height [mm]	2700		
Clear width of internal workspace [mm]	1150	1450	1750
Clear height of internal workspace [mm]	1550		
Working height [mm]	900		

Weight	1200	1500	1800
Without installation [kg]	Approx. 250	Approx. 300	Approx. 350

Design characteristics	1200	1500	1800
Supporting construction	Self-supporting underbench units or H-frame with push-in underbench units		
Sash	2 horizontal sashes		3 horizontal sashes
Side panel of the fume cupboard	Glass pane on the left and/or right as an option Material lock on the left and/or right as an option		
Max. number of devices for scaffold points, \varnothing 12 mm to 13 mm	9	12	
Max. load per scaffold point with scaffold rod length 300 mm [kg]	5		
Service modules	2	3	

Electrics	
Electrical supply	External sockets in service panels Internal sockets in service modules
Fuse box	Optional
Sash controller SC	Optional

Sanitary technology	
Sanitary supply	Service modules with take-off valves for vacuum, gases and/or waters and integrated sink (PP) as an option

Material/surface	
Worktop	Stoneware, Polypropylene, Stainless steel, Epoxy
Internal lining	Melamine resin facing, Solid grade laminate

Ventilation technology	1200	1500	1800
Minimum air exchange rate [m ³ /h] ¹⁾	330	410	490
Function display	FAZ		
Airflow damper, constant / variable	Airflow-Controller AC		
Detector of sash position	Only variable with Airflow-Controller AC		
Connection height [mm] for FAZ with extract manifold \varnothing 250 mm	2720		
Connection height [mm] for FAZ with extract manifold \varnothing 315 mm ²⁾	2850		
Connection height [mm] for AC with extract manifold \varnothing 250 mm	2950		
Connection height [mm] for AC with extract manifold \varnothing 315 mm ²⁾	3070		
Underbench exhaust	As an option, depending on requirements and regulations		

¹⁾ All air volume specifications refer to an opening height of the sash window of 500 mm (test opening in acc. with EN 14175) and the maximum tracer gas values recommended by German Standard (BG RCI). Shown rates correspond to a face velocity of 0.15 m/s. For other design face velocities, please contact your Waldner sales representative.

²⁾ In order to minimise noise and pressure losses, for air volumes >1000 m³/h Waldner recommends using the extract manifold with a connection diameter of 315 mm.

A maximum admission pressure of 600 Pa should not be exceeded in the case of fume cupboards with airflow dampers. The indicated minimum air exchange rates were determined under specified test conditions in acc. with EN 14175-3. These minimum air exchange rates must be adapted when dimensioning the ventilation system.

If on-site extract air monitoring systems or airflow dampers are used, the required air volumes may be different. The operating limitations must be agreed upon with Waldner.



Secuflow Green Fume Hood (GFH) – for recirculating air operation

Waldner is the only supplier on the market to have Secuflow fume cupboards with integrated filters for recirculating air in the product portfolio. Our Secuflow GFH with supportive flow technology can be operated with lower face velocity and provides a larger sash opening for working compared to competitive products.

Recirculating air operation

With the help of the Secuflow GFH, safe working conditions can be guaranteed even if there is insufficient capacity in the ventilation system.

This applies e.g. for:

- Expansion or refurbishment of existing laboratories (exclusive ventilation system)
- Laboratories with ventilation systems that are too small
- Multifunctional buildings with a low level of technical infrastructure.

Secuflow GFH offers the safest and most efficient solution for smooth workflows in the laboratory.

Secuflow GFH

The Secuflow GFH with filters for recirculating air operation – safe, flexible and efficient



Combination filter

The Secuflow GFH filter technology allows you to work with powder, solvents, acids and bases inside the fume cupboard. In order to ensure the safety guidelines, the quantity and type of chemicals used in the work process are queried and documented in advance. Based on the calculated Filter service life, the time of filter change is calculated, which can be carried out on request by our "Global Customer Service".



Lightning and prefiltering module

Safety and control

The built-in monitoring unit guarantees that only registered personnel can operate the Secuflow GFH. The saturation levels of the Neutrodine® filters are monitored by sensors. A Neutrodine® filter fitted downstream of the main filters also prevents pollutants from entering the laboratory in the event of penetration of the filter.

Secuflow GFH

SAFETY, FLEXIBILITY AND EFFICIENCY

Details

- Containment was tested on base of DIN 14175-3
- Permanent control of the extract air and filter saturation
- Filter redundancy

Laboratory

- No additional ventilation systems for room supply and exhaust air
- The placement is independent of the exhaust air connections

Environmental protection

- No emission of toxic substances to the environment
- Energy saving

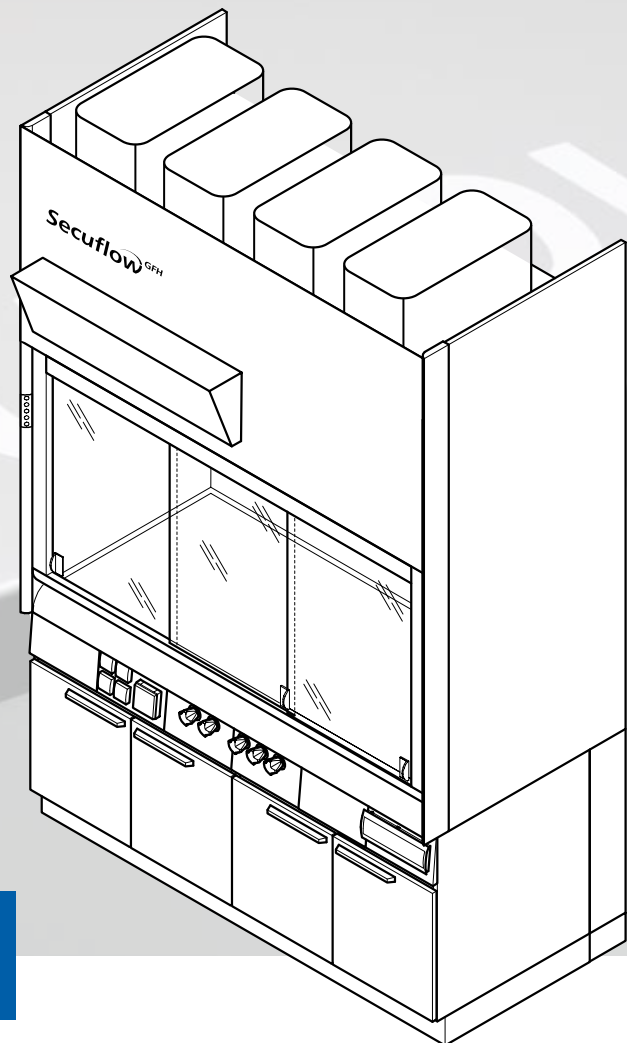

Secuflow Green Fume Hood (GFH) – for recirculating air operation

Intended use

- Protective equipment for users, executed according to EN 14175-2
- Extraction of fumes, aerosols and dust from the internal workspace.
- Protection against splashes of hazardous substances
- Protection against flying particles, bodies or parts from the internal workspace
- Reduction of energy consumption
- Service outlets in the rear panel of the fume cupboard
- Not suitable for open acid digestion
- Not suitable for gaseous chemicals which have a very low boiling point under normal temperature and room pressure conditions
- Not suitable for mercury
- Usually not suitable for use with radioactive substances or micro-organisms

Secuflow GFH

The Secuflow GFH with filters for recirculating air operation – safe, flexible and efficient



Adaptable Modular Filtration Column

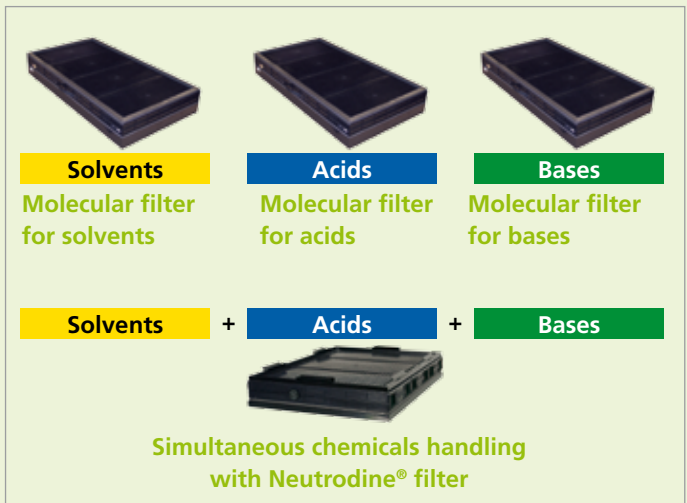

Versatile use of Neutrodine® filters versus specific filters

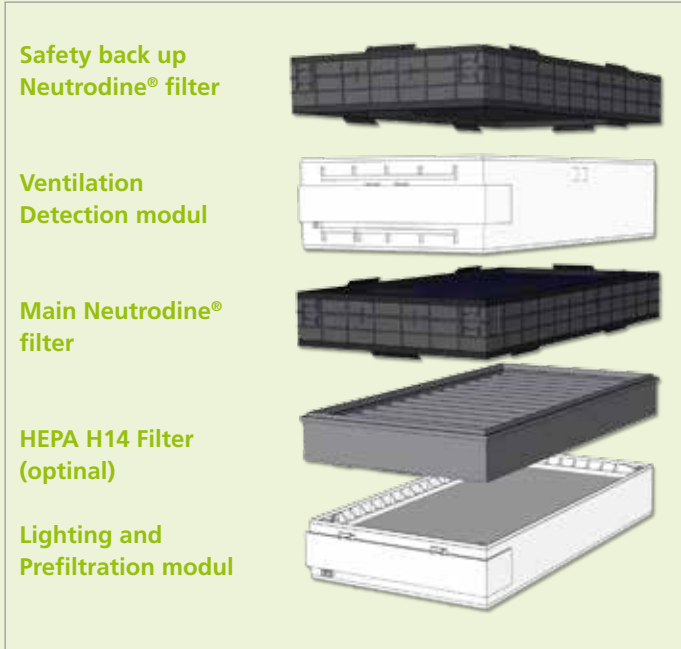

Adaptable Modular Filtration Column (AMFC™)

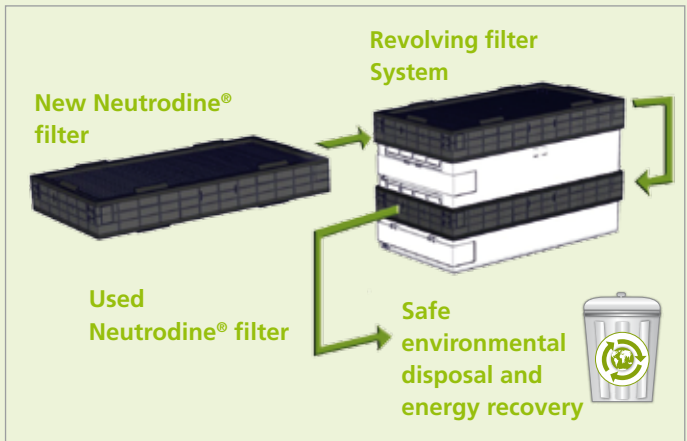

Revolving filter System

Filtration

- **Neutrodine®, a single molecular filter for all chemicals**
- Allows the simultaneous handlings of solvents, acid and bases with the same filter
- High retention capacities for an unprecedented level of safety
- Unique formulation, without carbon mixing
- No heavy metal impregnation used
- Neutrodine® filters performance tests according to the AFNOR NF X 15-211 standard
- **Powder filtration**
- High-efficiency HEPA filters used are H14 type filters, in accordance with standard EN 1822-1
- 99,995% global filtration efficiency for particles over 0.1 micron in size



Solvents detection sensor



Acids detection sensor

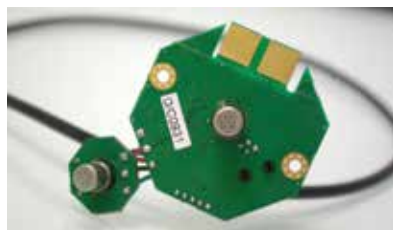

Laboratory air quality sensor



Technical data

Dimensions	1200	1500	1800
Width [mm]	1200	1500	1800
Depth [mm]	900		
Height [mm]	2700		
Clear width of internal workspace [mm]	1150	1450	1750
Clear height of internal workspace [mm]	1060		
Working height [mm]	900		

Weight	1200	1500	1800
Without installation [kg]	Ca. 250	Ca. 300	Ca. 350

Design characteristics	1200	1500	1800
Supporting construction	Self-supporting underbench units or H-frame with push-in underbench units		
Sash	One-piece		
Side panel of the fume cupboard	Glass panel on the left and/or right as an option Material lock on the left and/or right as an option		
Max. number of devices for scaffold points, \varnothing 12 mm to 13 mm	9		12
Max. load per scaffold point with scaffold rod length 300 mm [kg]	5		

Electrics	
Electrical supply	External sockets in service panels
Fuse box	Optional
Sash controller SC	Optional

Sanitary technology	
Sanitary supply	With take-off valves for vacuum, gases and/or waters and drip cup integrated in the worktop as an option

Material/surface	
Worktop	Stoneware, Epoxy
Internal lining	Melamine resin facing

Ventilation technology	1200	1500	1800
Recirculating air flow [m ³ /h]	450	675	900
Monitoring unit	GFH monitoring unit		
Filtration column incl. ventilation modul	2	3	4
Solvents sensor	1		
Temperature sensor	1		
Room air quality sensor	1		
Acids sensor	optional		

The minimum room height for the Secuflow GFH is 2750 mm.

Secuflow[®] GFH

The Secuflow GFH with filters for recirculating air operation – safe, flexible and efficient



WALDNER Laboreinrichtungen SE & Co. KG
Haidoesch 1 · 88239 Wangen · Germany
Phone +49 7522 986-0 · Fax +49 7522 986-418
labor@waldner.de · www.waldner.de

WALDNER