



Accessories Catalogue
Laboratory Furniture System SCALA

SCALA



WALDNER

Index

B

Balance table.....	43
Bench frame with C-frame.....	34
Bench frame with H-frame.....	33
Boxes for small parts.....	28
Bench frame with H-frame, height-adjustable.....	46
Buret clamp.....	15

C

Cap.....	22
Clamp box for waste bags.....	27
Clamp holder.....	15
Compartment partitioning.....	78
CPU holder.....	40
Cross-connector closed.....	13
Cross-connector hook connector.....	14
Cross-connector open.....	13

D

Dismantling tool.....	30
Document holder.....	25
Drawer insert type A.....	73
Drawer insert type B tray set.....	70

E

Emergency cabinet.....	63
Extraction arm, mobile.....	10
Extraction arm, stationary.....	9
Extractor hood.....	11

F

Funnel.....	82
-------------	----

G

Glass shelf.....	20
Glove box for disposable gloves.....	27

H

Hanging tray.....	28
Heavy duty mobile table.....	38
Heavy duty rack.....	45

L

Laboratory cabinet.....	58
Lateral pillars.....	18

M

MobilAir.....	6
Mobile housing.....	8
Mobile step stool.....	69
Mobile shelf.....	39
Mobile sink.....	41
Mobile table.....	36
Monitor arm.....	24

N

Name tag.....	80
---------------	----

O

Overbench cabinet.....	54
------------------------	----

P

Paper towel dispenser.....	25
Parking bracket.....	68
Pegboard.....	42
Pegboard for service duct.....	29
Pipette holder for drawers.....	79
Pipette holder with insertion holes.....	26
Pipette holder with mounting rail.....	26
Pipette tray for drawers.....	79
Pull-out basket.....	67
Pull-out cabinet.....	66

R

Rack.....	44
-----------	----

S

Scaffold points for fume cupboards.....	12
Scaffold points for lateral pillars.....	17
Scaffold rod.....	12
Service material lock.....	16
Shelf.....	62
Shelf of OSB board.....	19
Sliding element Assistant.....	48
Sliding element Protector.....	49
Sliding element Sekretär.....	47
Soap dispenser.....	23
Splash protection on worktop.....	30
Step ladder.....	69
Storage shelf made of glass for service duct.....	29
Suspended file insert.....	80
System step ladder.....	68

T

Task lighting.....	21
T-connector.....	14
Top-mounted cabinet.....	64
Towel dispenser, aluminium.....	23
Towel dispenser, plastic.....	23

U

Underbench unit on castors.....	50
Universal dispenser.....	24

W

Wall shelving.....	31
Waste canister for acids and alkalis.....	81
Waste canister for flammable liquids.....	81

About this catalogue

For our latest laboratory furniture system **SCALA** we have designed suitable accessories that are contained in the currently valid accessories catalogue. Its structure corresponds to our technical catalogue in order to make searching easy for you. The products are listed in alphabetical order in the index.

The technical catalogue contains the full range of our **SCALA** laboratory furniture system, complete with photos, dimensional drawings and technical data.

Copyright

We reserve the right to make technical changes in the context of further development. Photos, drawings and text content are copyright protected. Re-printing, even of extracts, is only authorised with the express approval of Waldner Laboreinrichtungen GmbH & Co. KG.

If you have any questions or are unable to find a product, we will be glad to help you.

WALDNER Laboreinrichtungen GmbH & Co.KG
Mr Yalcin Solak and Mr Bernd Brauchle
Haidoesch 1
88239 Wangen im Allgaeu
Germany

Phone: +49 7522 986-493
Fax : +49 7522 986-79493
zubehoer@waldner.de

Alternatively you can also visit the Accessories Shop on our website.

www.waldner-lab.de



Accessories SCALA Contents

1

Fume cupboards and extraction systems

Mobile fume cupboards	6	Scaffold material	12
MobilAir.....	6	Scaffold rod.....	12
Housings	8	Scaffold points for fume cupboards.....	12
Mobile housing.....	8	Cross-connector closed.....	13
Local extraction systems	9	Cross-connector open.....	13
Extraction arm, stationary.....	9	Cross-connector hook connector.....	14
Extraction arm, mobile.....	10	T-connector.....	14
Extractor hood.....	11	Buret clamp.....	15
		Clamp holder.....	15
		Add-on parts for fume cupboards	16
		Service material lock.....	16

2

Service modules

Add-on parts for service spines	17	Task lighting.....	21
Scaffold points for lateral pillars.....	17	Cap.....	22
Lateral pillars.....	18		
Shelf of OSB board.....	19		
Glass shelf.....	20		

2

Service modules

Add-on parts for service ducts	23	Clamp box for waste bags.....	27
Towel dispenser, plastic.....	23	Glove box for disposable gloves.....	27
Towel dispenser, aluminium.....	23	Hanging tray.....	28
Soap dispenser.....	23	Boxes for small parts.....	28
Universal dispenser.....	24	Storage shelf made of glass for service duct	29
Monitor arm.....	24	Pegboard for service duct.....	29
Document holder.....	25	Dismantling tool.....	30
Paper towel dispenser.....	25	Splash protection for worktop.....	30
Pipette holder with insertion holes.....	26	Add-on parts for wall-mounting	31
Pipette holder with mounting rail.....	26	Wall shelving.....	31

3

Laboratory benches and sinks

Worktop material	32	Laboratory sinks	39
Laboratory benches	33	Mobile sink.....	41
Bench frame with H-frame.....	33	Pegboard.....	42
Bench frame with C-frame.....	34	Special tables	43
Mobile tables	36	Balance table.....	43
Mobile table.....	36	Rack.....	44
Heavy duty mobile table.....	38	Heavy-duty rack.....	45
Add-on parts for worktop	39	Bench frame with H-frame, height-adjustable.....	46
Mobile shelf.....	39	Sliding elements	47
CPU holder.....	40	Sliding element Sekretär.....	47
		Sliding element Assistent.....	48
		Sliding element Protector.....	49

4

Storage cupboards

Underbench units	50	Ladders	68
Overbench cabinets	54	System step ladder.....	68
Laboratory cabinets	58	Parking bracket.....	68
Laboratory cabinet.....	58	Step ladder.....	69
Shelf.....	62	Mobile step stool.....	69
Emergency cabinet.....	63	Organising systems for drawers	70
Top-mounted cabinets	64	Drawer insert type B tray set.....	70
Pull-out cabinets	66	Drawer insert type A.....	73
Pull-out cabinet.....	66	Compartment partitioning.....	78
Pull-out basket.....	67	Pipette tray for drawers.....	79
		Pipette holder for drawers.....	79
		Suspended file insert.....	80
		Name tag.....	80

5

Supply and disposal

Canisters	81
Waste canister for acids and alkalis.....	81
Waste canister for flammable liquids.....	81
Funnel.....	82

Mobile fume cupboards

MobilAir



Intended use

- Can be used where required (only in air-circulating mode)
- Control units located externally

Technical data

Dimensions	
Width [mm]	900
Depth [mm]	600
Height with sash closed/open [mm]	1215/1620
Access width [mm]	730
Clear width of internal space [mm]	850
Effective depth [mm]	503
Clear internal height up to lamp [mm]	846
Clear internal height up to ceiling [mm]	935

Weight	
MobilAir for extract air operation [kg]	Approx. 70
MobilAir for air-circulating mode including filter [kg]	Approx. 82

Design characteristics	
Air-circulating mode	With ventilator and filter (see filter types)
Extract air operation	Extract air spigot connected to on-site extraction system
Lighting	Dazzle-free, can be switched from the outside
Sash	Movable vertically
Material lock	Possible on the left and/or right side of the fume cupboard

Electrics	
Electrical supply	2 external sockets in service panels
Total power of sockets [W]	1000
Connection voltage [V AC]	230
Lighting [W]	13
Ventilator power [W]	115

Ventilation technology	
Minimum air exchange rate [m ³ /h]	300
Function display	FAZ as an option
Connection height of upper edge of duct [mm] Extract air spigot Ø 125 mm	1137

Material	
Side panel design, sash	Plexiglas

Ordering information

Version	Order no.
MobilAir, extract air	81006271-A22
MobilAir recirculating air	81006271-U22

Scope of delivery
MobilAir, without filter (specify according to use)

Filter types for MobilAir

Filter type "A" No. 5, gas filter	
Dimensions [mm]	610 x 305 x 150 (+ 8 mm seal)
Pressure loss [Pa] at 300 m ³ /h	130
Design characteristics	Gas filter cell with 5 layers of active charcoal mat, type "A"; MDF frame; with white-painted grid on both sides, with grip and type label on the 610 mm side, PU seal on the dust-laden air side
Use	Separable substances: organic gases and vapours (e.g. solvents, petrol fumes, toluene, benzene, kerosene, odours, hydrocarbons with mass weights of 30 and higher), cold, non-boiling (VOC, high-boiling substances)

Filter type "BEP", gas filter cell	
Dimensions [mm]	610 x 305 x 150 (+ 8 mm seal)
Pressure loss [Pa] at 300 m ³ /h	240
Design characteristics	Combination filter Hepa H13 with active carbon mat and particle filter type "BEP"; MDF frame, with white-painted grid on both sides, with grip and type label on the 610 mm side, PU gasket on the dust-laden air side
Use	Separable substances: inorganic gases and vapours (e.g. chlorine, hydrosulfides, sulphur dioxide, hydrogen chlorides in cold and heated form). Molecules and particle separation 99.95% MPPS

Filter type "P", particle filter cell	
Dimensions [mm]	610 x 305 x 150 (+ 8 mm seal)
Pressure loss [Pa] at 300 m ³ /h	150
Design characteristics	Particle filter, type "P", Hepa H13, Midilar MDSA; MDF frame, with white-painted grid on both sides, with HD grip and type label on the 610 mm side, fold height 45 mm, PU gasket on the dust-laden air side, filter medium flush on the dust-laden air side
Use	Separable substances: Particle separation 99.95% MPPS, Hepa H13

Ordering information

Version	Order no.
Filter type "A"	81006315
Filter type "BEP"	81006317
Filter type "P"	81006318

Housings

Mobile housing



Intended use

- Can be used where required
- To minimise the impact of noise and contaminants
- Not suitable as a replacement for bench-mounted fume cupboards as per EN 14175

Technical data

Dimensions	
Width [mm]	600
Height [mm]	660
Height including extract air spigot [mm]	760
Access width [mm]	540
Access height [mm]	430
Depth [mm]	550
Effective depth [mm]	510

Version	
Extract air operation	Connected to on-site extract air system Optional extract manifold
Horizontal sash	3

Ventilation technology	
Extract air spigot for on-site connection ø [mm]	90

Material	
Horizontal sash	Plexiglas

Ordering information

Version	Order no.
Mobile housing	81004350

Extraction arm, stationary

Intended use

- For the extraction of a specific area
- For fixing to service wings, service spines or the wall

Technical data

Dimensions	50	75
Pipework system Ø [mm] ¹⁾	50	75
Coupling hood Ø [mm]	350	
Suction tip [mm]	50	75

¹⁾ Pipework system Ø 50 mm only for fastening to service wing

Ventilation technology	50	75
Minimum air exchange rate [m ³ /h]	50	100
Admission pressure [Pa]	150	150
Admission pressure [Pa] with Waldner airflow damper	200	200

Material	
Pipework	Anodised aluminium
Hinged bracket	Polypropylene
Coupling hood	Polycarbonate
Suction tip	Anodised aluminium

Ordering information

System components for local extraction system Ø 50 mm for service wing	Order no.
Suction tip, length 300 mm	81006328
Coupling hood	81006327
Quick coupling	81006329
3-section articulated arm, length 450/550/250 mm	81006326

System components for local extraction system Ø 75 mm	Order no.
Service spine bracket	81006325
Wall bracket	80013459
Suction tip, length 300 mm	80013457
Coupling hood	80013458
3-section articulated arm, length 450/550/250 mm	80013456



Local extraction systems

Extraction arm, mobile



Intended use

- For the extraction of a specific area
- For fastening to the service spine, flexibly movable within the spine grid

Technical data

Dimensions	
Pipework system Ø [mm] ¹⁾	75
Coupling hood Ø [mm]	350
Suction tip [mm]	75

¹⁾ Pipework system Ø 50 mm only for fastening to service wing

Ventilation technology	
Minimum air exchange rate [m ³ /h]	100
Admission pressure [Pa]	150
Admission pressure [Pa] with Waldner airflow damper	200

Material	
Pipework	Anodised aluminium
Hinged bracket	Polypropylene
Coupling hood	Polycarbonate
Suction tip	Anodised aluminium

Ordering information

Local extraction system Ø 75 mm with spine carriage and suction tip Width [mm]	Sales unit	Order no.
900	1 set	81011624
1200	1 set	81011625
1500	1 set	81011626
1800	1 set	81011627

Local extraction system Ø 75 mm with spine carriage and coupling hood Width [mm]	Sales unit	Order no.
900	1 set	81011620
1200	1 set	81011621
1500	1 set	81011622
1800	1 set	81011623

System components for local extraction system Ø 75 mm	Order no.
Suction tip, length 300 mm	80013457
Coupling hood	80013458
3-section articulated arm, length 450/550/250 mm	80013456

Extractor hood

Intended use

- For the extraction of a specific area
- For fixing to service spines and to the wall

Technical data

Dimensions	1200	1500
Width [mm]	1200	1500
Height x depth [mm]	300 x 600	
Extract air spigot Ø [mm]	200	

Ventilation technology	1200	1500
Minimum air exchange rate [m ³ /h]	480	600
Admission pressure [Pa]	25	30
Admission pressure [Pa] with Waldner airflow damper	150	150

Material	
Extractor hood	Polypropylene

Ordering information

Width [mm]	Order no.
1200	81007465-5W22
1500	81007465-6W22



Scaffold material

Scaffold rod



Intended use

- For fixing to scaffold points in the fume cupboard or on the service spine

Technical data

Dimensions	
Length [mm]	120, 300, 600, 900, 1100, 1200, 1400, 1500, 1700, 2000
Diameter [mm]	13

Material	
Scaffold rod	Stainless steel

Ordering information

Length [mm] (use)	Sales unit	Order no.
120	1	81006152
300	1	81006153
600	1	81006154
900	1	81006155
1100 (for horizontal use in the fume cupboard)	1	81011630
1200	1	81006156
1400 (for horizontal use in the fume cupboard)	1	81011631
1500	1	81006157
1700 (for horizontal use in the fume cupboard)	1	81011632
2000 (for horizontal use in the fume cupboard)	1	81011633

Scaffold points for fume cupboards



Intended use

- For mounting scaffold rods in the internal workspace
- For scaffold rods \varnothing 13 mm

Technical data

Design characteristics	
Construction	3-section bracket

Load-bearing capacity	
Capacity [kg]	5

Material	
Holding nut	PBT
Scaffold point	PBT

Ordering information

Name	Sales unit	Order no.
Scaffold point	1	81005039
Clamping nut	1	81005252
Holding nut	1	81005040

Cross-connector closed

Intended use

- For the connection of 2 scaffold rods
- For scaffold rods \varnothing 12 to 13 mm

Technical data

Design characteristics	
Construction	Stepless, independent, rectangular fixing Double socket closed



Ordering information

Material	Sales unit	Order no.
Stainless steel	1	81006166



Cross-connector open

Intended use

- For the connection of 2 scaffold rods
- For scaffold rods \varnothing 12 to 13 mm

Technical data

Design characteristics	
Construction	Open, rectangular clamping connection Stepless, independent, rectangular fixing 2 knurled screws



Ordering information

Material/colour	Sales unit	Order no.
Plastic/red	1	81006167



Scaffold material

Cross-connector hook connector



Intended use

- For the connection of 2 scaffold rods
- For scaffold rods \varnothing 12 to 13 mm

Technical data

Design characteristics	
Construction	Open clamp connection Stepless, independent, rectangular fixing 1 knurled screw



Ordering information

Material	Sales unit	Order no.
Nickel-plated steel	1	81006168

T-connector



Intended use

- For the connection of 2 scaffold rods
- For scaffold rods \varnothing 12 to 13 mm

Technical data

Design characteristics	
Construction	Open clamp connection Rectangular fixing Fixing at the end of the first scaffold rod, second scaffold rod can be fixed in any position 2 knurled screws

Ordering information

Material/colour	Sales unit	Order no.
Plastic/red	1	81006169



Buret clamp

Intended use

- For the connection of 2 scaffold rods
- For scaffold rods \varnothing 12 to 13 mm

Technical data

Design characteristics	
Construction	Closed clamp connection Stepless, independent fixing at any angle position 2 butterfly handles



Ordering information

Material/colour	Sales unit	Order no.
Plastic/anthracite, naturally anodised	1	81006170



Clamp holder

Intended use

- For the connection of 2 scaffold rods
- For scaffold rods \varnothing 12 to 13 mm

Technical data

Design characteristics	
Construction	Closed clamp connection Stepless, independent fixing at any angle position 1 clamp lever



Ordering information

Material/colour	Sales unit	Order no.
Plastic/anthracite, naturally anodised	1	81006171



Add-on parts for fume cupboard

Service material lock



Intended use

- Material lock to retrofit into solid side panel of fume cupboard for inserting cables or hoses
- Retrofittable to fume cupboards with rear panel installation, stand alone or in a row

Technical data

Dimensions	
Material lock diameter (internal) of membrane [mm]	approx. 70
Material lock ring [mm]	165 x 165
Cut-out dimension [mm]	150 x 150

Material	
Material lock ring	PP
Material lock membrane	Neoprene

Ordering information

Thickness [mm]	Sales unit	Order no.
42 (for two fume cupboards in a row)	1	81011852
24 (for an individual fume cupboard)	1	81011851



Add-on parts for service spine

Scaffold points for lateral pillars

Intended use

- For mounting scaffold rods
- For scaffold rods \varnothing 12 to 13 mm

Technical data

Dimensions	
Width [mm] front/rear	23/23
Depth [mm] front/rear	23/23
Height [mm] front/rear	30/35
Load-bearing capacity	
Capacity [kg]	5
Design characteristics	
Construction	Two-piece holder with hook and clamping screw for scaffold rod



Ordering information

Material	Sales unit	Order no.
Aluminium die-cast	1 set	81002723

Scope of delivery

- 1 holder with hook
- 1 holder with hook and clamping screw

Add-on parts for service spine

Lateral pillars



Intended use

- For attaching to service module upright
- For glass shelves and OSB boards, and for scaffold points

Technical data

Dimensions	
Width [mm]	171
Depth [mm]	3
Height [mm]	382

Ordering information

Material	Sales unit	Order no.
Steel	1 set	81002720-322

Scope of delivery

2 lateral pillars

Add-on parts for service spine

Shelf of OSB board

Intended use

- For assembly on service spines on existing lateral pillars

Technical data

Dimensions					
Width [mm]	600	900	1200	1500	1800
Depth [mm]	300				
Thickness [mm] of shelf	22				
Height [mm] of lateral pillar	382				

Load-bearing capacity	
Total [kg]	30

Material	
Shelf	OSB board with melamine resin facing
Lateral pillar	Steel
Bracket	Aluminium die-cast
Angle bracket	Stainless steel



Ordering information

Width [mm]	Sales unit	Order no.
600	1 set	81002722-322
900	1 set	81002722-422
1200	1 set	81002722-522
1500	1 set	81002722-622
1800	1 set	81002722-722

Scope of delivery

- 1 shelf
- 2 brackets for shelf
- 1 angle bracket for shelf

Add-on parts for service spine

Glass shelf



2nd level,
glass shelf with bracket
150 mm deep

1st level,
flush glass shelf
105 mm deep

Intended use

- For suspending in service spines on existing lateral pillars

Technical data

Dimensions					
Width [mm]	600	900	1200	1500	1800
Depth [mm] 1st level	105				
Depth [mm] 2nd level	150				
Height [mm] of lateral pillar	382				
Load-bearing capacity					
Total [kg]	20				
Material					
Shelf	Glass				
Lateral pillar	Steel				

Ordering information

Dimensions	Width x depth [mm]	Sales unit	Order no.
1st level	600 x 105	1	81000977
	900 x 105	1	81000978
	1200 x 105	1	81000979
	1500 x 105	1	81000980
	1800 x 105	1	81000981
2nd level	600 x 150	1 set	81002721-322
	900 x 150	1 set	81002721-422
	1200 x 150	1 set	81002721-522
	1500 x 150	1 set	81002721-622
	1800 x 150	1 set	81002721-722

Scope of delivery for 2nd level

- 1 glass shelf
- 2 brackets for glass shelf
- 1 angle bracket for glass shelf

Add-on parts for service spine

Task lighting

Intended use

- For assembly on existing shelf or on suspended cabinet
- For fixed connection or plug-in (standard plug)

Technical data

Dimensions					
Width [mm]	600	900	1200	1500	1800
Depth [mm]	40				
Height [mm] of lateral pillar	15				

Material	
Housing	Aluminium
Lamp glass	Acrylic glass
Lamp	extremely long-life 80 mW LED

Ordering information

Width [mm]	Sales unit	Order no.
600	1	81016101
900	1	81016102
1200	1	81016103
1500	1	81016104
1800	1	81016105

Scope of delivery

1 lamp with switch including lamp and fluorescent lamp ballast, with connecting cable

Connecting cable

Version	Sales unit	Order no.
connecting lead 2m with Euro plug	1	81016107
connecting lead 2 m with Wieland-Plug GST18i3	1	81016106



Add-on parts for service spine

Cap



Intended use

- To cover open hanging slots in the service module upright

Technical data

Dimensions	
Width [mm]	5.5
Height [mm]	22

Ordering information

Material	Sales unit	Order no.
Plastic	1 set	81011080

Scope of delivery
6 caps

Towel dispenser, plastic

Intended use

- For use as a combined paper towel dispenser for paper towels (width 240 mm, DU 155 mm) or paper towels with C- or Z-fold, 250 x 230 mm format, to fit Tork, Satino, Quicky and Van Houtum towels

Technical data

Dimensions	
Width x depth x height [mm]	195 x 251 x 300

Ordering information

Material	Order no.
Plastic	81006405

Scope of delivery

1 towel dispenser with key without paper towels



Towel dispenser, aluminium

Intended use

- For paper towels with C- or Z-fold, 250 x 230 mm format, to fit Tork, Satino, Quicky and Van Houtum towels

Technical data

Dimensions	
Width x depth x height [mm]	130 x 185 x 275

Ordering information

Material	Order no.
Aluminium	81006406

Scope of delivery

1 towel dispenser with key without paper towels



Soap dispenser

Intended use

- For liquid soap with refillable 1100 ml container without cartridges, suitable for use with Clivia liquid soap

Technical data

Dimensions	
Width x depth x height [mm]	130 x 115 x 220

Ordering information

Material	Order no.
Plastic	81006407

Scope of delivery

1 soap dispenser, closable without soap



Add-on parts for service duct

Universal dispenser



Intended use

- For liquid soap, hand cleaner, disinfectant etc. removable cartridge to fill with all popular liquids

Technical data

Dimensions	
500 ml Width x depth x height [mm]	82 x 162 x 273
1000 ml Width x depth x height [mm]	94 x 162 x 325
Material	
Universal dispenser	Anodised aluminium

Ordering information

Capacity	Order no.
500 ml	81006408
1000 ml	81006409

Scope of delivery

1 universal dispenser without soap

Monitor arm



Intended use

- For flat screens with VESA holder 75 x 75 mm / 100 x 100 mm
- For service spines with service duct and fascia panel

Technical data

Dimensions	
Width x depth x height [mm]	280 x 390 x 283
Load-bearing capacity	
Capacity [kg]	10
Design characteristics	
Construction	Vertically pivotable (45°) Horizontally rotatable and movable

Ordering information

Material	Order no.
Steel	81010387-2

Scope of delivery

2 clamping adapters for service duct
1 monitor cantilever

Add-on parts for service duct

Document holder

Intended use

- For storing and filling with report sheets
- For service spines with service duct and fascia panel

Technical data

Dimensions	Cantilever	Holder panel
Width x depth x height [mm]	280 x 390 x 283	400 x 36 x 300

Load-bearing capacity	
Capacity [kg]	10

Design characteristics	
Construction	Vertically pivotable (45°) Horizontally rotatable and movable



Ordering information

Material	Order no.
Steel	81010388-2

Scope of delivery

- 2 clamping adapters for service duct
- 1 document cantilever
- 1 holder panel

Paper towel dispenser

Intended use

- For holding paper towels

Technical data

Dimensions	
Width x depth x height [mm]	270 x 146 x 88



Ordering information

Material	Order no.
Steel	81005867-2

Scope of delivery

- 2 clamping adapters for service duct
- 1 paper towel dispenser

Add-on parts for service duct

Pipette holder with insertion holes



Intended use

- To accommodate 11 pipettes

Technical data

Dimensions	
Width x depth x height [mm]	297 x 175 x 66
Insertion openings [mm]	5 x Ø 26 6 x Ø 20

Ordering information

Material	Order no.
Steel/plastic (PE)	81005866-2

Scope of delivery

- 2 clamping adapters for service duct
- 1 screw-on frame for pipette holder
- 1 plate for pipettes

Pipette holders with mounting rail



Intended use

- To accommodate pipettes with suspension hooks

Technical data

Dimensions	
Width x depth x height [mm]	300 x 41 x 80
Mounting rail [mm]	Ø 21

Ordering information

Material	Order no.
Steel/plastic	81010132-2

Scope of delivery

- 2 clamping adapters for service duct
- 1 screw-on frame for pipette holder
- 1 mounting rail for pipettes

Add-on parts for service duct

Clamp box for waste bags

Intended use

- To hold waste bags, to dispose of pipette tips and small items of waste

Technical data

Dimensions		
Width x depth x height [mm]	103 x 103 x 142	



Ordering information

Material	Order no.
Steel	81010131-2

Scope of delivery

- 1 clamp box
- 1 clamping adapters for service duct

Glove box for disposable gloves

Intended use

- To hold a dispenser box for disposable gloves up to a depth of 95 mm
- Optional with clamping rail for fixing smaller dispenser boxes

Technical data

Material		
Steel		

Ordering information

Dimensions			Order no.
Glove box	Width x depth x height [mm]	135 x 126 x 240	81013982
Clamping rail	Width x depth x height [mm]	152 x 13 x 39	81013983

Scope of delivery

- 1 clamp box
- 2 clamping adapters for service duct



Add-on parts for service duct

Hanging tray



Intended use

- For mounting on the service duct

Technical data

Dimensions	
Width x depth x height [mm]	297 x 230 x 49
Load-bearing capacity	
Capacity [kg]	5

Ordering information

Material	Order no.
Steel	81005869-2

Scope of delivery

2 clamping adapters for service duct
1 hanging tray

Boxes for small parts



Intended use

- For storing small parts

Technical data

The colours of the boxes for small parts are subject to technical changes.

Dimensions	
Boxes for small parts with mounting rail Width x depth x height [mm]	516 x 203 x 80
Small boxes Width x depth x height [mm]	100 x 160 x 75
Load-bearing capacity	
Capacity [kg]	5

Ordering information

Material	Order no.
Plastic/aluminium	81005871-2

Scope of delivery

2 clamping adapters for service duct
1 mounting rail with bracket
5 boxes for small parts

Storage shelf made of glass for service duct

Intended use

- For mounting on the service duct

Technical data

Dimensions	
Width x depth [mm]	560 x 150

Load-bearing capacity	
Capacity [kg]	5



Ordering information

Version	Order no.
Storage shelf made of glass for service duct	81005868-2

Scope of delivery

- 2 clamping adapters
- 1 screw-on frame
- 1 glass plate

Pegboard for service duct

Intended use

- Frame for drying laboratory glasses

Technical data

Dimensions	
Pegboard Width x height [mm]	300 x 260
Draining peg [mm]	Ø 12 Ø 9

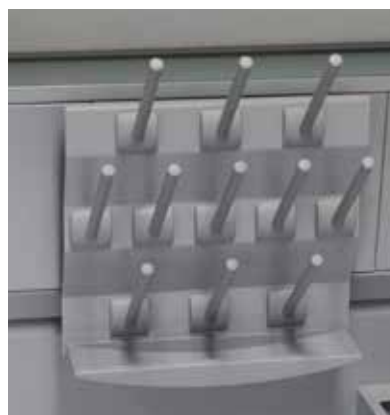

Ordering information

Version	Sales unit	Order no.
Pegboard for service duct, 11 draining pegs, diameter 12 mm	1 set	81005861-2

Scope of delivery

- 1 pegboard with 11 draining pegs, diameter 12 mm
- 1 basin for drips
- 1 fastening

Version	Sales unit	Order no.
Draining peg Ø 12	1	81006177
Draining peg Ø 9	1	81011766

Add-on parts for service duct

Dismantling tool



Intended use

- Suction lifter for dismantling service panels

Technical data

Dimensions	
Diameter [mm]	82
Height [mm]	50

Ordering information

Material	Order no.
Rubber	81006178

Splash protection on worktop



Intended use

- Movable splash and splinter guard fitted to the service duct

Technical data

Dimensions	
Width [mm]	8
Depth [mm]	750 900
Height [mm]	450

Design characteristics

Construction

Material

Splash protection Tempered safety glass

Ordering information

Depth [mm]	Order no.
750	81005864-52
900	81005864-62

Scope of delivery

- 2 clamping adapters for service duct
- 1 clamp
- 2 feet
- 1 splash protection screen

Add-on parts for wall-mounting

Wall shelving

Intended use

- For mounting on the wall
- To store reagents or as a document shelf

Technical data

Dimensions					
Width [mm]	600	900	1200	1500	1800
Height [mm] of lateral pillar	390				

Load-bearing capacity [kg]	
Glass shelf	20
Shelf of OSB board	30
Total	60

Material	
Shelf	Glass
Lateral pillar / mounting rail	Steel

Ordering information

Dimensions		Sales unit	Order no.
Length [mm]	390	1 set	81010134

Scope of delivery

- 2 wall rails
- 2 lateral pillars
- 1 fastening set

Dimensions	Width x depth [mm]	Sales unit	Order no.
	600 x 150	1 set	81002721-322
	900 x 150	1 set	81002721-422
	1200 x 150	1 set	81002721-522
	1500 x 150	1 set	81002721-622
	1800 x 150	1 set	81002721-722

Scope of delivery

- 1 glass shelf
- 2 brackets for glass shelf
- 1 angle bracket for glass shelf

Dimensions	Width x depth [mm]	Sales unit	Order no.
600	600 x 300	1 set	81002722-322
900	900 x 300	1 set	81002722-422
1200	1200 x 300	1 set	81002722-522
1500	1500 x 300	1 set	81002722-622
1800	1800 x 300	1 set	81002722-722

Scope of delivery

- 1 shelf
- 2 brackets for shelf
- 1 angle bracket for shelf











Wall rail set

Glass shelf

Shelf of OSB board

Laboratory benches and sinks

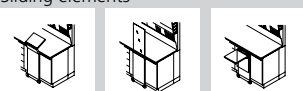
Material, worktop		Coated particle-board	Solid (grade) laminate	Solid (grade) laminate Trespa Toplab+	Polypropylene	Epoxy	Stainless steel	Stoneware	Compound stoneware worktop	Glass
H-frame		x	x	x	x	x	x	x	x	x
C-frame		x	x	x	x	x	x	x	x	x
Cantilever frame		x	x	x	x	x	x	x	x	x
Mobile table		x	x	x	x	x	x	-	-	x
H-frame for low level fume cupboards		-	-	-	x ⁴⁾	x ⁴⁾	x ⁴⁾	x ⁴⁾	-	-
Balance table		x	-	-	-	-	-	-	-	-
Swing		x ¹⁾	-	-	-	-	-	-	-	-
Round table		x ¹⁾	-	-	-	-	-	-	-	-
Rack		x ²⁾	-	-	-	-	-	-	-	-
Sliding elements		x ³⁾	-	-	-	-	-	-	-	-

1) Oak trim or light grey

2) Shelf white, top of Sekretär in oak trim

3) Only oak trim

4) Material with surrounding increased edge

H-frame

Intended use

- Bench frame for laboratory bench as a worktop and storage area for laboratory work, worktop available in different materials, depending on the requirement
- Supporting construction for analytical equipment and superstructures

Technical data

Dimensions					
Width [mm]	600	900	1200	1500	1800
Depth [mm]				600	
				750	
				900	
Working height [mm]				750	
				900	

Load-bearing capacity	
H-frame [kg]	200 (for wall-mounting or for assembly on a service spine)

Design characteristics	
Construction	For movable underbench units, can be moved for all kinds of frames
Height-adjustable feet	Individually adjustable
Worktop	optional

Material	
Bench frame	Steel profile 60/25/2 mm
Worktop	Depending on the requirement, see page 30
Height-adjustable feet	Plastic housing with steel spindle

Ordering information

Select and order the worktop separately.

Width x depth [mm]	Sales unit	Order no.
600 x 600	1	81000837-367F0022
600 x 750	1	81000837-377F0022
600 x 900	1	81000837-397F0022
900 x 600	1	81000837-467F0022
900 x 750	1	81000837-477F0022
900 x 900	1	81000837-497F0022
1200 x 600	1	81000837-567F0022
1200 x 750	1	81000837-577F0022
1200 x 900	1	81000837-597F0022
1500 x 600	1	81000837-667F0022
1500 x 750	1	81000837-677F0022
1500 x 900	1	81000837-697F0022
1800 x 600	1	81000837-767F0022
1800 x 750	1	81000837-777F0022
1800 x 900	1	81000837-797F0022



H-frame
working height 750 mm

Scope of delivery
1 bench frame

Laboratory benches

H-frame working height 900 mm

Width x depth [mm]	Sales unit	Order no.
600 x 600	1	81000837-369F0022
600 x 750	1	81000837-379F0022
600 x 900	1	81000837-399F0022
900 x 600	1	81000837-469F0022
900 x 750	1	81000837-479F0022
900 x 900	1	81000837-499F0022
1200 x 600	1	81000837-569F0022
1200 x 750	1	81000837-579F0022
1200 x 900	1	81000837-599F0022
1500 x 600	1	81000837-669F0022
1500 x 750	1	81000837-679F0022
1500 x 900	1	81000837-699F0022
1800 x 600	1	81000837-769F0022
1800 x 750	1	81000837-779F0022
1800 x 900	1	81000837-799F0022

Scope of delivery

1 bench frame

C-frame



Intended use

- Bench frame for laboratory bench as a worktop and storage area for laboratory work, worktop available in different materials, depending on the requirement
- Supporting construction for analytical equipment and superstructures

Technical data

Dimensions					
Width [mm]	600	900	1200	1500	1800
Depth [mm]	600 750 900				
Working height [mm]	750 900				

Load-bearing capacity

C-frame [kg]	200
--------------	-----

Design characteristics

Construction	For movable underbench units, can be moved for all kinds of frames
Height-adjustable feet	Individually adjustable
Worktop	optional

Material

Bench frame	Steel profile 70/25/3 mm
Worktop	Depending on the requirement, see page 30
Height-adjustable feet	Plastic housing with steel spindle

Laboratory benches

Ordering information

Select and order the worktop separately.

Width x depth [mm]	Sales unit	Order no.
600 x 600	1	81000836-367F0022
600 x 750	1	81000836-377F0022
600 x 900	1	81000836-397F0022
900 x 600	1	81000836-467F0022
900 x 750	1	81000836-477F0022
900 x 900	1	81000836-497F0022
1200 x 600	1	81000836-567F0022
1200 x 750	1	81000836-577F0022
1200 x 900	1	81000836-597F0022
1500 x 600	1	81000836-667F0022
1500 x 750	1	81000836-677F0022
1500 x 900	1	81000836-697F0022
1800 x 600	1	81000836-767F0022
1800 x 750	1	81000836-777F0022
1800 x 900	1	81000836-797F0022

Scope of delivery

1 bench frame

**C-frame
working height 750 mm**

Width x depth [mm]	Sales unit	Order no.
600 x 600	1	81000836-369F0022
600 x 750	1	81000836-379F0022
600 x 900	1	81000836-399F0022
900 x 600	1	81000836-469F0022
900 x 750	1	81000836-479F0022
900 x 900	1	81000836-499F0022
1200 x 600	1	81000836-569F0022
1200 x 750	1	81000836-579F0022
1200 x 900	1	81000836-599F0022
1500 x 600	1	81000836-669F0022
1500 x 750	1	81000836-679F0022
1500 x 900	1	81000836-699F0022
1800 x 600	1	81000836-769F0022
1800 x 750	1	81000836-779F0022
1800 x 900	1	81000836-799F0022

Scope of delivery

1 bench frame

**C-frame
working height 900 mm**

Laboratory benches and sinks

Mobile tables

Mobile table



Intended use

- Movable bench frame with worktop made of various materials as a work surface and storage area for laboratory work
- Movable supporting construction for analytical equipment and superstructures

Technical data

Dimensions			
Width [mm]	900	1200	1500
Depth [mm]		600	750
		750	900
Working height [mm]		750	900

Load-bearing capacity	
Mobile table [kg]	150

Design characteristics	
Heavy load castors	4, 2 of which can be locked (castor and steering axle can be locked)
Shelf	Optional
Underbench unit	Optional

Material	
Bench frame	Steel profile 60/25/2 mm
Worktop	Standard version melamine resin-faced chipboard optional depending on the requirement, see page 30

Mobile tables

Ordering information

The order numbers listed below apply to chipboard with melamine resin facing. Worktops made of other materials are available on request.

Width x depth [mm]	Sales unit	Order no.
900 x 600	1	81005251-467AE022
900 x 750	1	81005251-477AE022
900 x 900	1	81005251-497AE022
1200 x 600	1	81005251-567AE022
1200 x 750	1	81005251-577AE022
1200 x 900	1	81005251-597AE022
1500 x 600	1	81005251-667AE022
1500 x 750	1	81005251-677AE022
1500 x 900	1	81005251-697AE022

Mobile table, working height 750 mm
without shelf

Width x depth [mm]	Sales unit	Order no.
900 x 600	1	81005251-469AE022
900 x 750	1	81005251-479AE022
900 x 900	1	81005251-499AE022
1200 x 600	1	81005251-569AE022
1200 x 750	1	81005251-579AE022
1200 x 900	1	81005251-599AE022
1500 x 600	1	81005251-669AE022
1500 x 750	1	81005251-679AE022
1500 x 900	1	81005251-699AE022

Mobile table, working height 900 mm
without shelf

Scope of delivery

1 bench frame, 1 worktop, standard design, 4 swivelling castors (2 can be locked) without shelf

Width x depth [mm]	Sales unit	Order no.
900 x 600	1	81005251-467AE122
900 x 750	1	81005251-477AE122
900 x 900	1	81005251-497AE122
1200 x 600	1	81005251-567AE122
1200 x 750	1	81005251-577AE122
1200 x 900	1	81005251-597AE122
1500 x 600	1	81005251-667AE122
1500 x 750	1	81005251-677AE122
1500 x 900	1	81005251-697AE122

Mobile table, working height 750 mm
with shelf

Width x depth [mm]	Sales unit	Order no.
900 x 600	1	81005251-469AE122
900 x 750	1	81005251-479AE122
900 x 900	1	81005251-499AE122
1200 x 600	1	81005251-569AE122
1200 x 750	1	81005251-579AE122
1200 x 900	1	81005251-599AE122
1500 x 600	1	81005251-669AE122
1500 x 750	1	81005251-679AE122
1500 x 900	1	81005251-699AE122

Mobile table, working height 900 mm
with shelf

Scope of delivery

1 bench frame, 1 worktop, standard design, 4 swivelling castors (2 can be locked), 1 shelf

Mobile tables

Heavy duty mobile table



Intended use

- Movable heavy duty table frame for transporting heavy loads and as a work and storage area for laboratory work, worktop available in different materials, as required

Technical data

Dimensions		
Width [mm]	1200	1500
Depth [mm]	750	900
Working height [mm]	900	

Load-bearing capacity	
Total [kg]	500
Intermediate side shelf [kg]	32
Bottom shelf [kg]	150

Design characteristics	
Heavy load castors	4, 2 of which can be locked (castor and steering axle can be locked)
Intermediate side shelf 400 x 690 x 30 [mm]	Optional, max. 2 pieces

Material	
Bench frame	Steel profile 60/25/2 mm
Shelf	chipboard with melamine resin facing
Intermediate side shelf	chipboard with melamine resin facing
Worktop	Depending on the requirement, see page 30

Ordering information

Select and order the worktop separately.

Width x depth [mm]	Sales unit	Order no.
1200 x 750	1	81010992-571022
1200 x 900	1	81010992-591022
1500 x 750	1	81010992-671022
1500 x 900	1	81010992-691022

Scope of delivery

1 bench frame
4 swivelling castors (2 can be locked)
1 shelf

Intermediate side shelf	Sales unit	Order no.
Shelf (without cantilevers)	1	81010994-570022
Left cantilever (1 x intermediate shelf)	1	81008712
Right cantilever (1 x intermediate shelf)	1	81008711

Add-on parts for worktop

Mobile shelf

Intended use

- For assembly on the worktop (clamping range 16-110 mm)

Technical data

Dimensions					
Width [mm]	600	900	1200	1500	1800
Height [mm] of lateral pillar	540				

Load-bearing capacity [kg]	
Glass shelf	20
Shelf of OSB board	30
Total	60

Material	
Lateral pillar / mounting rail	Steel



Ordering information

Dimensions		Sales unit	Order no.
Length [mm]	540	1 set	81011997

Scope of delivery

- 1 clamp foot set
 - 1 lateral pillar
- Please note: Order 2 no. clamp foot sets for each mobile shelf

Dimensions	Width x depth [mm]	Sales unit	Order no.
	600 x 150	1 set	81002721-322
	900 x 150	1 set	81002721-422
	1200 x 150	1 set	81002721-522
	1500 x 150	1 set	81002721-622
	1800 x 150	1 set	81002721-722

Scope of delivery

- 1 glass shelf
- 2 brackets for glass shelf
- 1 angle bracket for glass shelf

Dimensions	Width x depth [mm]	Sales unit	Order no.
600	600 x 300	1 set	81002722-322
900	900 x 300	1 set	81002722-422
1200	1200 x 300	1 set	81002722-522
1500	1500 x 300	1 set	81002722-622
1800	1800 x 300	1 set	81002722-722

Scope of delivery

- 1 shelf
- 2 brackets for shelf
- 1 angle bracket for shelf

Clamp foot set

Glass shelf

Shelf of OSB board

Add-on parts for worktop

CPU holder

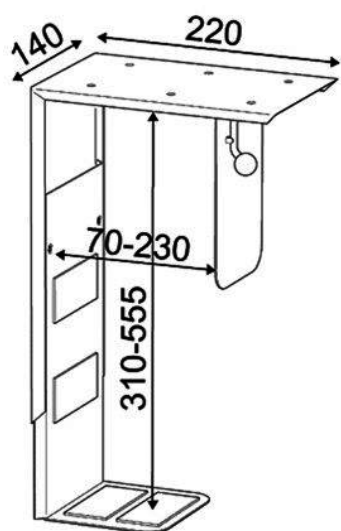

Intended use

- To fit under the worktop

Technical data

Dimensions	
Height [mm]	325 - 570
Width [mm]	140
Length [mm]	220
Load-bearing capacity	
Capacity [kg]	20
Design characteristics	
Construction	Bracket for screwing under the worktop to accommodate a CPU casing, adjustable - height (310-510 mm) with locking mechanism, - width (70-230 mm) continuous

Ordering information

Material	Sales unit	Order no.
Steel	1	81006411

Mobile sink

Intended use

- Mobile water and gas supply and disposal
- For cleaning operating equipment at any location
- Not suitable for the disposal of chemicals

Technical data

Dimensions	
Width [mm]	605
Depth [mm]	600
Height without outlet [mm]	900
Sink dimensions, width x depth x height [mm]	320 x 320 x 200
Height [mm] of castors	110
Length of supply and drain pipes [mm]	2500
Length of connecting pipes [mm]	2500

Material	
Worktop	Chipboard with melamine resin facing
Sink	Polypropylene

Load bearing capacity	
Mobile sink [kg]	150

Design characteristics	
Construction	<p>Mounted on underbench unit on castors with hinged door</p> <p>Sink installed in the worktop from above</p> <p>Pipes and cables routed out at the rear of the underbench unit</p> <p>Waste water lifting unit in the underbench unit</p> <p>Water supply is switched off in the case of a power failure</p>

Electrics	
Power supply [V]	230

Sanitary technology	
Water connection	Flexible with plug connector
Waste water connection	Flexible with plug connector
Gas connection	Flexible with plug connector as an option
Water fitting (tap)	Standard outlet
Gas outlet	Optional bench-mounted service outlet combined with water fitting (tap)
Mixer tap	Additional flexible water connection as an option

Ordering information

Version	Order no.
Mobile sink	81004358-B0222



Laboratory sinks

Pegboard



Intended use

- Frame for drying laboratory glasses
- For fixing above sinks on service module uprights or for wall mounting

Technical data

Dimensions	
Pegboard width x height [mm]	600 x 360
18 Draining pegs	
Draining peg [mm]	Ø 12

Design characteristics	
Construction	Cover panel with pegboard and removable drainage sink

Ordering information

Version	Sales unit	Order no.
Pegboard, 18 draining pegs, diameter 12 mm	1 set	81005862-22

Scope of delivery

- 1 core
- 2 pegboards with 18 draining pegs, diameter 12 mm
- 2 basins for drips

Version	Sales unit	Order no.
Draining peg Ø 12	1	81006177
Draining peg Ø 9	1	81011766

Balance table

Intended use

- For setting up analytical scales and other sensitive measuring equipment
- Bench frame with worktop and specially mounted, vibration-free plate

Technical data

Dimensions	
Width [mm]	900
Depth [mm]	750 900
Working height [mm]	750 900
Width x depth [mm] of balance plate	400 x 450

Material	
Supporting construction	Steel profile
Worktop	Standard version, melamine resin-faced chipboard optional depending on the requirement, see page 30
Balance plate	Fine concrete

Weight	
Total weight [kg]	120
Balance plate [kg]	65

Design characteristics	
Construction	Specially mounted, heavy balance plate made of fine concrete Supporting construction with balance plate, vibration-decoupled

Ordering information

The order numbers listed below apply to chipboard with melamine resin facing. Worktops made of other materials are available on request.

Working height x depth [mm]	Sales unit	Order no.
750 x 750	1 set	81005710-2A2
750 x 900	1 set	81005710-3A2
900 x 750	1 set	81009320-2A2
900 x 900	1 set	81009320-3A2

Scope of delivery

- 1 bench frame
- 1 covering for bench frame
- 1 balance plate
- 1 worktop, standard design (melamine resin facing)



Special tables

Rack



Intended use

- Mobile flexible storage area
- Can be used with the 600 mm deep shelf as a mobile workplace for desk work
- Not suitable for laboratory work where hazardous substances have to be extracted
- Not suitable for storing hazardous substances

Technical data

Dimensions	
Width [mm] with shelf	900
Depth [mm] with shelf depth 450 mm	600
Height [mm]	1790
Depth of shelf [mm]	450 600

Material	
Supporting construction	Steel profile
Shelf 22 mm	Shelf of OSB board

Load-bearing capacity	
Total [kg]	150
Shelf [kg]	20

Design characteristics	
Heavy load castors	4, 2 of which can be locked (castor and steering axle can be locked)
Shelf	Can be adjusted without tools at 150 mm increments
Integrated cable cabinet	Optional

Ordering information

Version	Sales unit	Order no.
Rack	1 set	81005369-31022

Scope of delivery

- 1 supporting construction
- 1 shelf, depth 600 mm
- 3 shelves, depth 450 mm

Heavy duty rack

Intended use

- Mobile multi-stage storage area
- With flexible work surfaces for free horizontal configuration
- Suitable for accommodating stackable and non-stackable measuring instruments / measuring instrument towers
- Suitable for heavy equipment

Technical data

Dimensions		
Width [mm]	1200	1800
Depth [mm]	765	
Height [mm]	1790	
Shelf with cantilever, width x depth [mm]	400 x 590	400 x 590
Shelf for hanging, width x depth [mm]	1070 x 750	1670 x 750
Lower shelf, width x depth [mm]	1070 x 750	1670 x 750

Material	
Supporting construction	Steel profile 70 x 40 mm
Shelf and storage area	Shelf of OSB board

Load-bearing capacity	
Total	500 [kg]
Shelf with cantilever	30 [kg]
Shelf for hanging 1200 [mm]	70 [kg]
Shelf for hanging 1800 [mm]	70 [kg]
Lower shelf 1200 [mm]	150 [kg]
Lower shelf 1800 [mm]	150 [kg]

Design characteristics	
Heavy load castors	4, 2 of which can be locked (castor and steering axle can be locked)
Shelf	Can be adjusted with at 75 mm increments

Ordering information

Width [mm]	Sales unit	Order no.
1200	1	81010995-522
1800	1	81010995-722

Scope of delivery

1 frame with heavy load castors
1 bottom shelf

Shelf	Sales unit	Order no.
Shelf with cantilever	1	81010998-522
Shelf for hanging 1200 [mm]	1	81010997-522
Shelf for hanging 1800 [mm]	1	81010997-722
Lower shelf 1200 [mm]	1	81011002-522
Lower shelf 1800 [mm]	1	81011002-722



Special tables

Height-adjustable H-frame



Intended use

- Bench frame for laboratory bench as a height-adjustable worktop and storage area for laboratory work, worktop available with different materials, depending on the requirement
- Supporting construction for analytical equipment and superstructures

Technical data

Dimensions		
Width [mm]	1200	1500
Depth [mm] in front of spine	750 / 900	
Depth [mm] free-standing	750	
Working height [mm]	700 - 950	

Material	
Bench frame	Steel profile 60/25/2 mm
Worktop	Depending on the requirement, see page 30
Height-adjustable feet	Plastic housing with steel spindle

Load-bearing capacity	
Total [kg]	200

Design characteristics	
Working height	Can be adjusted with at 25 mm increments
Bench frame	H-frame
Height-adjustable feet	Individually adjustable

Ordering information

Select and order the worktop separately.

Width x depth [mm]	Sales unit	Order no.
1200 x 750	1	81005350-52
1500 x 750	1	81005350-62

Scope of delivery

1 bench frame, height-adjustable

Sliding element Sekretär

Intended use

- Inclined desk that can be moved on a laboratory work bench

Technical data

Dimensions	
Width [mm]	416
Working height, bench [mm]	900
Overall height [mm]	1244

Design characteristics	
Construction	Sliding element on 2 wheels Fastened to a sliding rail on the laboratory work bench

Material	
Sliding element	Particle-board with melamine resin facing in oak trim

Ordering information

Only allow qualified staff to fit the sliding rail; cannot be retrofitted to stoneware worktops.

Version	Order no.
Sliding element Sekretär	81005359-322



Sliding elements

Sliding element Assistant



Intended use

- Fold-out storage area and desk that can be moved along a laboratory work bench

Technical data

Dimensions	
Width [mm]	406
Depth [mm]	530
Working height, bench [mm]	900
Load-bearing capacity	
Storage area and desk [kg]	10
Design characteristics	
Construction	Sliding element on 2 wheels Fastened to a sliding rail on the laboratory work bench Can be folded down completely
Material	
Sliding element	Particle-board with melamine resin facing in oak trim

Ordering information

Only allow qualified staff to fit the sliding rail; cannot be retrofitted to stoneware worktops.

Version	Order no.
Sliding element Assistant	81005358-322

Sliding element Protector

Intended use

- Splash and splinter protection that can be moved along a laboratory work bench

Technical data

Dimensions	
Width [mm]	406
Working height, bench [mm]	900
Overall height [mm]	1800

Design characteristics	
Construction	Sliding element on 2 wheels Fastened to a sliding rail on the laboratory work bench

Material	
Sliding element	Particle-board with melamine resin facing in oak trim
Splash protection	Tempered safety glass



Ordering information

Only allow qualified staff to fit the sliding rail; cannot be retrofitted to stoneware worktops.

Version	Order no.
Sliding element Protector	81005360-322

Underbench units

Underbench unit on castors



Intended use

- For storing equipment and chemicals flexibly in line with EN 14727
- For working heights of 750 mm and 900 mm
- Not suitable for storing flammable liquids, gas cylinders and self-igniting or self-decomposing substances
- Not suitable for storing acids and alkalis

Technical data

Dimensions							
Width [mm]	450	545	600	845	900	1145	1200
Depth [mm]	550						
Overall height [mm]	640 790						
Height, drawers [mm]	150 200 350 See different versions for combination options						
Height of castors [mm]	110						

Load-bearing capacity	
Per shelf/drawer [kg]	30
Per castor [kg]	70

Design characteristics	
Construction	For working height of 750 and 900 mm Hinged doors with 270° hinges Drawers, fully extensible and with alternate-pull-out catch Shelf, height-adjustable Without doors as a rack Covered at the top, rear panel permanently connected to the carcass 4 swivelling castors, front castors can be locked
Combination options	See versions
Handle	SCALA handle (standard design) Stainless steel D-handle (optional)
Closing	Optional

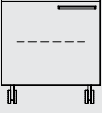
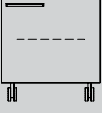
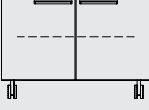

Underbench units

Ordering information

Version	Width x depth x height [mm]	Sales unit	Order no.
1 hinged door, left 	450 x 550 x 640	1 set	81002302-2G10022
	545 x 550 x 640	1 set	81002304-2G10022
	600 x 550 x 640	1 set	81002306-2G10022
1 hinged door, right 	450 x 550 x 640	1 set	81002303-2G10022
	545 x 550 x 640	1 set	81002305-2G10022
	600 x 550 x 640	1 set	81002307-2G10022
2 hinged doors 	845 x 550 x 640	1 set	81002308-2G10022
	900 x 550 x 640	1 set	81002309-2G10022
	1145 x 550 x 640	1 set	81002310-2G10022
	1200 x 550 x 640	1 set	81002311-2G10022

Scope of delivery

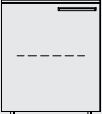
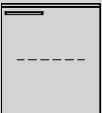
- 1 underbench unit with hinged door(s)
- 1 shelf
- 4 swivelling castors (2 can be locked)

Version	Width x depth x height [mm]	Sales unit	Order no.
1 hinged door, left 	450 x 550 x 790	1 set	81002328-2G10022
	545 x 550 x 790	1 set	81002330-2G10022
	600 x 550 x 790	1 set	81002332-2G10022
1 hinged door, right 	450 x 550 x 790	1 set	81002329-2G10022
	545 x 550 x 790	1 set	81002331-2G10022
	600 x 550 x 790	1 set	81002333-2G10022
2 hinged doors 	845 x 550 x 790	1 set	81002334-2G10022
	900 x 550 x 790	1 set	81002335-2G10022
	1145 x 550 x 790	1 set	81002336-2G10022
	1200 x 550 x 790	1 set	81002337-2G10022

Scope of delivery

- 1 underbench unit with hinged door(s)
- 1 shelf
- 4 swivelling castors (2 can be locked)

Underbench unit with hinged door, for working height 750 mm

Underbench unit with hinged door, for working height 900 mm

Storage cupboards

Underbench units

Underbench unit with drawers,
for working height 750 mm

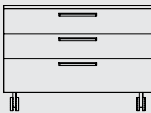
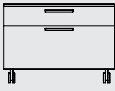
Version	Width x depth x height [mm]	Sales unit	Order no.
3 drawers (height 2 x 150, 1 x 200 mm) 	450 x 550 x 640	1 set	81002312-2G00022
	600 x 550 x 640	1 set	81002313-2G00022
	900 x 550 x 640	1 set	81002314-2G00022
	1200 x 550 x 640	1 set	81002315-2G00022
2 drawers (height 150, 350 mm) 	450 x 550 x 640	1 set	81002316-2G00022
	600 x 550 x 640	1 set	81002317-2G00022
	900 x 550 x 640	1 set	81002318-2G00022
	1200 x 550 x 640	1 set	81002319-2G00022

Scope of delivery

1 underbench unit with drawer (change-pull-out catch)
4 swivelling castors (2 can be locked)

Underbench unit with drawers,
for working height 900 mm

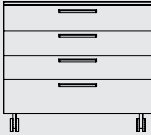
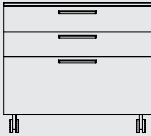
Version	Width x depth x height [mm]	Sales unit	Order no.
4 drawers (height 3 x 150, 1 x 200 mm) 	450 x 550 x 790	1 set	81002338-2G00022
	600 x 550 x 790	1 set	81002339-2G00022
	900 x 550 x 790	1 set	81002340-2G00022
	1200 x 550 x 790	1 set	81002341-2G00022
3 drawers (height 2 x 150, 1 x 350 mm) 	450 x 550 x 790	1 set	81002342-2G00022
	600 x 550 x 790	1 set	81002343-2G00022
	900 x 550 x 790	1 set	81002344-2G00022
	1200 x 550 x 790	1 set	81002345-2G00022

Scope of delivery

1 underbench unit with drawer (change-pull-out catch)
4 swivelling castors (2 can be locked)

Underbench unit with hinged
door and drawers, for working
height 750 mm

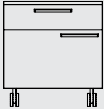
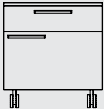
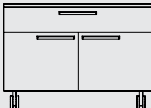
Version	Width x depth x height [mm]	Sales unit	Order no.
1 drawer, 1 hinged door left 	450 x 550 x 640	1 set	81002320-2G00022
	600 x 550 x 640	1 set	81002322-2G00022
1 drawer, 1 hinged door right 	450 x 550 x 640	1 set	81002321-2G00022
	600 x 550 x 640	1 set	81002323-2G00022
1 drawer, 2 hinged doors 	900 x 550 x 640	1 set	81002324-2G00022
	1200 x 550 x 640	1 set	81002325-2G00022

Scope of delivery

1 underbench unit with drawer and hinged door(s)
4 swivelling castors (2 can be locked)

Underbench units

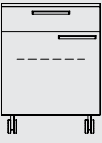
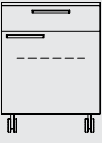
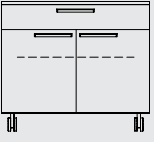
Version	Width x depth x height [mm]	Sales unit	Order no.
1 drawer, 1 hinged door, left 	450 x 550 x 790	1 set	81002346-2G10022
	600 x 550 x 790	1 set	81002348-2G10022
1 drawer, 1 hinged door, right 	450 x 550 x 790	1 set	81002347-2G10022
	600 x 550 x 790	1 set	81002349-2G10022
1 drawer, 2 hinged doors 	845 x 550 x 790	1 set	81002350-2G10022
	900 x 550 x 790	1 set	81002351-2G10022
	1145 x 550 x 790	1 set	81002352-2G10022
	1200 x 550 x 790	1 set	81002353-2G10022

Scope of delivery

1 underbench unit with drawer and hinged door(s)
1 shelf
4 swivelling castors (2 can be locked)

Underbench unit with hinged door and drawers, for working height 900 mm

Shelf

Version	For carcass width [mm]	Width x depth x thickness [mm]	Sales unit	Order no.
Melamine resin facing 	450	410 x 488 x 19	1	81001369
	545	506 x 488 x 19	1	81001370
	600	560 x 488 x 19	1	81001371
	845	806 x 488 x 22	1	81001372
	900	860 x 488 x 22	1	81001373
	1145	1106 x 488 x 22	1	81001374
	1200	1160 x 488 x 22	1	81001375

Scope of delivery

1 shelf
with shelf bracket

Shelf for underbench unit on castors, underbench unit on plinth and underbench unit for fume cupboards

Overbench cabinets

Overbench cabinet



Intended use

- For storing equipment and chemicals in acc. with EN 14727
- Not permitted for storing flammable liquids, gas cylinders and self-igniting or self-decomposing substances
- Not permitted for storing acids and alkalis

Technical data







Dimensions				
Width [mm]	450	600	900	1200
Depth [mm]	350			
Height [mm]	460			
	760			

Load-bearing capacity	
Per shelf [kg]	30
Total load-bearing capacity [kg]	60

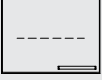
Design characteristics	
Construction	Height-adjustable fitting for fastening to the wall or to the service spine For a width of 1200 mm with central panel Shelf, height-adjustable
Combination options	See versions
Handle	SCALA handle/ bonded plastic handle for glass sliding doors (standard version) Stainless steel D-handle (optional)
Shelving with inclined side walls	Optional
Closing	Optional

Ordering information

The order numbers listed below apply to overbench cabinets for wall-mounting. Overbench cabinets for mounting to services spines are available on request.

Version	Width x depth [mm]	Sales unit	Order no.
1 hinged door, left	450 x 350	1 set	81002642-G10W22
	600 x 350	1 set	81002644-G10W22
1 hinged door, right	450 x 350	1 set	81002643-G10W22
	600 x 350	1 set	81002645-G10W22
2 hinged doors with central panel	900 x 350	1 set	81002650-G10W22
	1200 x 350	1 set	81002651-G10W22
1 hinged door, glazed, left	450 x 350	1 set	81002630-G10W22
	600 x 350	1 set	81002632-G10W22
1 hinged door, glazed, right	450 x 350	1 set	81002631-G10W22
	600 x 350	1 set	81002633-G10W22
2 hinged doors, glazed, with central panel	900 x 350	1 set	81002638-G10W22
	1200 x 350	1 set	81002639-G10W22

Scope of delivery

- 1 overbench cabinet with hinged door(s)
- 1 shelf (for carcass width 1200 mm: 1 central panel, 2 shelves)

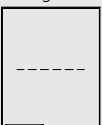
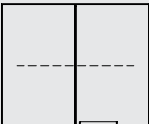
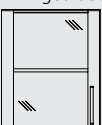

Version	Width x depth [mm]	Sales unit	Order no.
1 hinged door, left	450 x 350	1 set	81002646-G10W22
	600 x 350	1 set	81002648-G10W22
1 hinged door, right	450 x 350	1 set	81002647-G10W22
	600 x 350	1 set	81002649-G10W22
2 hinged doors with central panel	900 x 350	1 set	81002652-G10W22
	1200 x 350	1 set	81002653-G10W22
1 hinged door, glazed, left	450 x 350	1 set	81002634-G10W22
	600 x 350	1 set	81002636-G10W22

Overbench cabinet with hinged door, height 460 mm

Overbench cabinet with hinged door, height 760 mm

Overbench cabinets

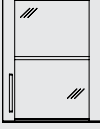
Overbench cabinet with hinged door, height 760 mm

Version	Width x depth [mm]	Sales unit	Order no.
1 hinged door, glazed, right 	450 x 350	1 set	81002635-G10W22
	600 x 350	1 set	81002637-G10W22
2 hinged doors, glazed, with central panel 	900 x 350	1 set	81002640-G10W22
	1200 x 350	1 set	81002641-G10W22

Scope of delivery

1 overbench cabinet with hinged door(s)
1 shelf (for carcass width 1200 mm: 1 central panel, 2 shelves)

Overbench cabinet with glass door, height 460 mm

Version	Width x depth [mm]	Sales unit	Order no.
Glass door 	900 x 350	1 set	81002675-010W02
	1200 x 350	1 set	81002676-010W02

Scope of delivery

1 overbench cabinet with central panel
2 glass doors
1 shelf (for carcass width 1200 mm: 1 central panel, 2 shelves)

Overbench cabinet with glass door, height 760 mm

Version	Width x depth [mm]	Sales unit	Order no.
Glass door 	900 x 350	1 set	81002677-010W02
	1200 x 350	1 set	81002678-010W02

Scope of delivery

1 overbench cabinet with central panel
2 glass doors
1 shelf (for carcass width 1200 mm: 1 central panel, 2 shelves)

Overbench cabinet without doors, height 460 mm

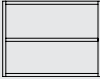
Version	Width x depth [mm]	Sales unit	Order no.
Shelving 	450 x 350	1 set	81002614-010W02
	600 x 350	1 set	81002615-010W02
	900 x 350	1 set	81002616-010W02
	1200 x 350	1 set	81002620-010W02

Scope of delivery

1 overbench cabinet without doors
1 shelf (for carcass width 1200 mm: 1 central panel, 2 shelves)

Overbench cabinet without doors, height 760 mm

Version	Width x depth [mm]	Sales unit	Order no.
Shelving 	450 x 350	1 set	81002617-010W02
	600 x 350	1 set	81002618-010W02
	900 x 350	1 set	81002619-010W02
	1200 x 350	1 set	81002621-010W02

Scope of delivery

1 overbench cabinet without doors
1 shelf (for carcass width 1200 mm: 1 central panel, 2 shelves)

Overbench cabinets

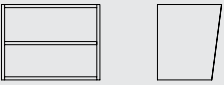
Version	Width x depth [mm]	Sales unit	Order no.
Rack with inclined side wall 	450 x 350	1 set	81002622-010W02
	600 x 350	1 set	81002623-010W02
	900 x 350	1 set	81002624-010W02
	1200 x 350	1 set	81002628-010W02

Scope of delivery

1 overbench cabinet without doors with inclined side wall
 1 shelf (for carcass width 1200 mm: 1 central panel, 2 shelves)

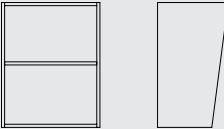
Version	Width x depth [mm]	Sales unit	Order no.
Rack with inclined side wall 	450 x 350	1 set	81002625-010W02
	600 x 350	1 set	81002626-010W02
	900 x 350	1 set	81002627-010W02
	1200 x 350	1 set	81002629-010W02

Scope of delivery

1 overbench cabinet without doors with inclined side wall
 1 shelf (for carcass width 1200 mm: 1 central panel, 2 shelves)

Version	For carcass width [mm]	Width x depth x thickness [mm]	Sales unit	Order no.
Melamine resin facing 	450	410 x 288 x 19	1	81001361
	600	560 x 288 x 19	1	81001362
	900	860 x 288 x 22	1	81001363
	1200	570 x 288 x 19	2	81001360

Scope of delivery

1 shelf (for carcass width 1200 mm: 2 shelves)
 with shelf bracket

Overbench cabinet without doors with inclined side wall, height 460 mm

Overbench cabinet without doors with inclined side wall, height 760 mm

Shelf for overbench cabinet

Storage cupboards

Laboratory cabinets

Laboratory cabinet



Intended use

- For storing equipment and chemicals in acc. with EN 14727
- Not permitted for storing flammable liquids, gas cylinders and self-igniting or self-decomposing substances
- Not permitted for storing acids and alkalis

Technical data

Dimensions				
Width [mm]	450	600	900	1200
Depth [mm]	350 550			
Overall height [mm]	2090			
Height of plinth [mm]	110			

Load-bearing capacity	
Per shelf [kg]	30

Design characteristics	
Construction	Hinged doors with 270° hinges Shelves, height-adjustable Drawers, fully extendable 4 height-adjustable feet
Combination options	See versions Drawers only with a depth of 550 mm
Handle	SCALA handle (standard design) Stainless steel D-handle (optional)
Shelves, extendable	Optional (with a cabinet depth of 550 mm)
Drawers	Optional (with a cabinet depth of 550 mm)
Extract air spigot	Optional
Closing	Optional

Ordering information

Laboratory cabinet without door





Version	Width x depth x height [mm]	Sales unit	Order no.
	450 x 350 x 2090	1 set	81002516-3040002
	450 x 550 x 2090	1 set	81002516-5040002
	600 x 350 x 2090	1 set	81002517-3040002
	600 x 550 x 2090	1 set	81002517-5040002
	900 x 350 x 2090	1 set	81002518-3040002
	900 x 550 x 2090	1 set	81002518-5040002
	1200 x 350 x 2090	1 set	81002519-3040002
	1200 x 550 x 2090	1 set	81002519-5040002

Scope of delivery

1 laboratory cabinet without door
4 shelves

Laboratory cabinets

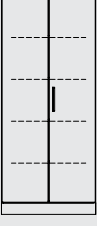
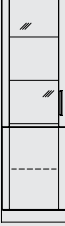

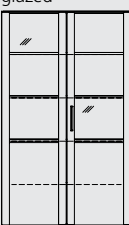
Storage cupboards

Version	Width x depth x height [mm]	Sales unit	Order no.
1 hinged door, left 	450 x 350 x 2090	1 set	81002510-3G40022
	600 x 350 x 2090	1 set	81002512-3G40022
	450 x 550 x 2090	1 set	81002510-5G40022
	600 x 550 x 2090	1 set	81002512-5G40022
1 hinged door, right 	450 x 350 x 2090	1 set	81002511-3G40022
	600 x 350 x 2090	1 set	81002513-3G40022
	450 x 550 x 2090	1 set	81002511-5G40022
	600 x 550 x 2090	1 set	81002513-5G40022
2 hinged doors 	900 x 350 x 2090	1 set	81002514-3G40022
	1200 x 350 x 2090	1 set	81002515-3G40022
	900 x 550 x 2090	1 set	81002514-5G40022
	1200 x 550 x 2090	1 set	81002515-5G40022
1 hinged door, partially glazed, left 	450 x 350 x 2090	1 set	81007486-3G40022
	600 x 350 x 2090	1 set	81007488-3G40022
	450 x 550 x 2090	1 set	81007486-5G40022
	600 x 550 x 2090	1 set	81007488-5G40022
1 hinged door, partially glazed, right 	450 x 350 x 2090	1 set	81007487-3G40022
	600 x 350 x 2090	1 set	81007489-3G40022
	450 x 550 x 2090	1 set	81007487-5G40022
	600 x 550 x 2090	1 set	81007489-5G40022
2 hinged doors, partially glazed 	900 x 350 x 2090	1 set	81007490-3G40022
	1200 x 350 x 2090	1 set	81002526-3G40022
	900 x 550 x 2090	1 set	81007490-5G40022
	1200 x 550 x 2090	1 set	81002526-5G40022

Laboratory cabinet with hinged door

Laboratory cabinets

Laboratory cabinet with hinged door

Version	Width x depth x height [mm]	Sales unit	Order no.
1 hinged door, glazed, left 	450 x 350 x 2090	1 set	81007482-3G40022
	600 x 350 x 2090	1 set	81007484-3G40022
	450 x 550 x 2090	1 set	81007482-5G40022
	600 x 550 x 2090	1 set	81007484-5G40022
1 hinged door, glazed, right 	450 x 350 x 2090	1 set	81007483-3G40022
	600 x 350 x 2090	1 set	81007485-3G40022
	450 x 550 x 2090	1 set	81007483-5G40022
	600 x 550 x 2090	1 set	81007485-5G40022
2 hinged doors, glazed 	900 x 350 x 2090	1 set	81002524-3G40022
	1200 x 350 x 2090	1 set	81002525-3G40022
	900 x 550 x 2090	1 set	81002524-5G40022
	1200 x 550 x 2090	1 set	81002525-5G40022

Scope of delivery

1 laboratory cabinet with hinged door(s), 4 shelves

Laboratory cabinet with folding door

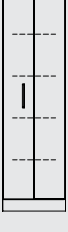
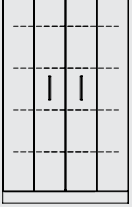



Version	Width x depth x height [mm]	Sales unit	Order no.
1 folding door, left 	600 x 350 x 2090	1 set	81002520-3G40022
	600 x 550 x 2090	1 set	81002520-5G40022
1 folding door, right 	600 x 350 x 2090	1 set	81002521-3G40022
	600 x 550 x 2090	1 set	81002521-5G40022
2 folding doors 	900 x 350 x 2090	1 set	81002522-3G40022
	900 x 550 x 2090	1 set	81002522-5G40022
	1200 x 350 x 2090	1 set	81002523-3G40022
	1200 x 550 x 2090	1 set	81002523-5G40022

Scope of delivery

1 laboratory cabinet with folding door(s), 4 shelves

Laboratory cabinets

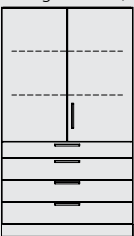
Storage cupboards

Version	Width x depth x height [mm]	Sales unit	Order no.
1 hinged door, left, 4 drawers	600 x 550 x 2090	1 set	81002529-5G20022
			
1 hinged door, right, 4 drawers	600 x 550 x 2090	1 set	81002530-5G20022
			
2 hinged doors, 4 drawers	900 x 550 x 2090	1 set	81002531-5G20022
			
	1200 x 550 x 2090	1 set	81002532-5G20022
2 hinged doors, 8 drawers	900 x 550 x 2090	1 set	81002533-5G20022
			
	1200 x 550 x 2090	1 set	81002534-5G20022

Scope of delivery

- 1 laboratory cabinet with hinged door(s)
- 2 shelves
- 4 or 8 drawers depending on design

Laboratory cabinet with hinged door and drawer

Laboratory cabinets

Shelf

Shelf for laboratory cabinet depth 350 mm

Version	For carcass width [mm]	Width x depth x thickness [mm]	Sales unit	Order no.
Melamine resin facing 	450	410 x 288 x 19	1	81001361
	600	560 x 288 x 19	1	81001362
	900	860 x 288 x 22	1	81001363
	1200	1160 x 288 x 22	1	81001364

Scope of delivery

1 shelf
with shelf bracket

Shelf for laboratory cabinet depth 550 mm

Version	For carcass width [mm]	Width x depth x thickness [mm]	Sales unit	Order no.
Melamine resin facing 	450	410 x 488 x 19	1	81001369
	600	560 x 488 x 19	1	81001371
	900	860 x 488 x 22	1	81001373
	1200	1160 x 488 x 22	1	81001375

Scope of delivery

1 shelf
with shelf bracket

Emergency cabinet

Intended use

- For storing protection and rescue materials (fire extinguisher, first aid case etc.)
- Not permitted for storing flammable liquids, gas cylinders and self-igniting or self-decomposing substances
- Not permitted for storing acids and alkalis



Technical data

Dimensions	
Width [mm]	600
Depth [mm]	350 550
Overall height [mm]	2090
Height of plinth [mm]	110

Design characteristics	
Construction	Hinged door with 270° hinges 4 shelves, height-adjustable 4 height-adjustable feet
Equipment	First aid case Fire extinguisher, 5 kg Sand boxes Shovel Fire blankets
Handle	SCALA handle (standard design) Stainless steel D-handle (optional)



Ordering information

Version	Width x depth x height [mm]	Sales unit	Order no.
1 hinged door, left 	600 x 350 x 2090	1 set	81002910-3G40022
	600 x 550 x 2090	1 set	81002910-5G40022
1 hinged door, right 	600 x 350 x 2090	1 set	81002911-3G40022
	600 x 550 x 2090	1 set	81002911-5G40022

Scope of delivery

- 1 laboratory cabinet with hinged door
- 4 shelves
- 1 first aid case
- 1 fire extinguisher
- 2 sand boxes
- 1 sand shovel
- 2 fire blankets

Top-mounted cabinets

Top-mounted cabinet



Intended use

- For storing equipment and chemicals in acc. with EN 14727
- Only suitable as a permanently installed top unit on the following Waldner cabinets: Laboratory cabinet, pull-out cabinet, emergency cabinet and acids and alkalis cabinet
- Not permitted for storing flammable liquids, gas cylinders and self-igniting or self-decomposing substances
- Not permitted for storing acids and alkalis

Technical data

Dimensions				
Width [mm]	450	600	900	1200
Depth [mm]		350		
		550		
Height [mm]		610		
		760		

Load-bearing capacity	
Per shelf [kg]	30

Design characteristics	
Construction	With integral rail for securing a ladder For laboratory cabinets with or without extract air spigot 1 shelf, height-adjustable Hinged doors
Handle	SCALA handle (standard design) Stainless steel D-handle (optional)
Hook ladder	Optional
Closing	Optional

Ordering information

Top-mounted cabinet,
height 610 mm

Version	Width x depth [mm]	Sales unit	Order no.
1 hinged door, left 	450 x 350	1 set	81002663-3G1022
	600 x 350	1 set	81002665-3G1022
	450 x 550	1 set	81002663-5G1022
	600 x 550	1 set	81002665-5G1022
1 hinged door, right 	450 x 350	1 set	81002664-3G1022
	600 x 350	1 set	81002666-3G1022
	450 x 550	1 set	81002664-5G1022
	600 x 550	1 set	81002666-5G1022
2 hinged doors 	900 x 350	1 set	81002671-3G1022
	1200 x 350	1 set	81002672-3G1022
	900 x 550	1 set	81002671-5G1022
	1200 x 550	1 set	81002672-5G1022

Scope of delivery

- 1 top-mounted cabinet with hinged door(s)
- 1 shelf

Top-mounted cabinets

Version	Width x depth [mm]	Sales unit	Order no.
1 hinged door, left 	450 x 350	1 set	81002667-3G1022
	600 x 350	1 set	81002669-3G1022
	450 x 550	1 set	81002667-5G1022
	600 x 550	1 set	81002669-5G1022
1 hinged door, right 	450 x 350	1 set	81002668-3G1022
	600 x 350	1 set	81002670-3G1022
	450 x 550	1 set	81002668-5G1022
	600 x 550	1 set	81002670-5G1022
2 hinged doors 	900 x 350	1 set	81002673-3G1022
	1200 x 350	1 set	81002674-3G1022
	900 x 550	1 set	81002673-5G1022
	1200 x 550	1 set	81002674-5G1022

Scope of delivery

1 top-mounted cabinet with hinged door(s)
1 shelf

Top-mounted cabinet,
height 760 mm

Shelf

Version	For carcass width [mm]	Width x depth x thickness [mm]	Sales unit	Order no.
Melamine resin facing 	450	410 x 288 x 19	1 set	81001361
	600	560 x 288 x 19	1 set	81001362
	900	860 x 288 x 22	1 set	81001363
	1200	1160 x 288 x 22	1 set	81001364

Scope of delivery

1 shelf
with shelf bracket

Shelf for top-mounted cabinet
depth 350 mm

Version	For carcass width [mm]	Width x depth x thickness [mm]	Sales unit	Order no.
Melamine resin facing 	450	410 x 488 x 19	1 set	81001369
	600	560 x 488 x 19	1 set	81001371
	900	860 x 488 x 22	1 set	81001373
	1200	1160 x 488 x 22	1 set	81001375

Scope of delivery

1 shelf
with shelf bracket

Shelf for top-mounted cabinet
depth 550 mm

Pull-out cabinets

Pull-out cabinet



Intended use

- For storing liquid or solid substances in suitable containers in line with EN 14727
- Not permitted for storing flammable liquids, gas cylinders and self-igniting or self-decomposing substances
- Not permitted for storing acids and alkalis

Technical data

Dimensions		
Width [mm]	600	900
Depth [mm]	550	
Overall height [mm]	2090	
Height of plinth [mm]	110	
Hanging basket, width x depth x height [mm]	240 x 425 x 40	

Load-bearing capacity	
Per drawer [kg]	120
Per pull-out basket / pull-out tray [kg]	10

Design characteristics	
Construction	5 hanging baskets with tray, height-adjustable, per pull-out Fastened to the wall 4 height-adjustable feet Drawer doors with drawers accessible from both sides
Handle	SCALA pull handle (standard version) Stainless steel D-handle (optional)
Soft stop for drawer	Optional
Extract air spigot	Optional
Closing	Optional

Material	
Collection tray	Polyethylene

Ordering information

Width [mm]	Sales unit	Order no.
600 (2 drawers)	1 set	81002752-G00122
900 (3 drawers)	1 set	81002753-G00122

Scope of delivery

- 1 pull-out cabinet
- 5 pull-out baskets in each drawer

Pull-out basket

Intended use

- For storing medium-sized containers of up to approx. 1 litre with solid or liquid substances

Technical data

Material	
Collection tray	Polyethylene
Pull-out basket	Steel



Ordering information

Design characteristic	Width x depth x height [mm]	Sales unit	Order no.
Pull-out basket with tray	240 x 425 x 40	1	81000922

Scope of delivery

- 1 wire basket
- 1 tray
- 2 hanging brackets

Ladders

System step ladder



Intended use

- For attaching to top-mounted cabinets

Technical data

Dimensions	
Width [mm]	405
Height [mm]	2330

Load-bearing capacity	
Capacity [kg]	150

Ordering information

Material	Sales unit	Order no.
Aluminium	1	81006175

Parking bracket



Intended use

- Screw bracket for the safe storage of a stepladder with hanging hooks
- Can be screwed to the wall or to the side of a top-mounted cabinet

Technical data

Dimensions	
Width x depth x height [mm]	500 x 49 x 120

Design characteristics	
Construction	Coated particle-board (19 mm) with PP trim on all sides with stainless steel screw D-handles

Ordering information

Material	Sales unit	Order no.
Coated chipboard / stainless steel	1	81007517-22

Step ladder

Technical data

Dimensions	
Width x depth x length [mm]	422 x 70 x 2330
Load-bearing capacity	
Capacity [kg]	150
Design characteristics	
Construction	With 4 steps

Ordering information

Material	Sales unit	Order no.
Aluminium	1	81006174



Mobile step stool

Technical data

Dimensions	
Height [mm]	430
Load-bearing capacity	
Capacity [kg]	150
Design characteristics	
Construction	With 2 steps With 3 spring-borne sliding casters and non-slip rubber coating

Ordering information

Material	Sales unit	Order no.
Steel	1	81006176



Organising systems for drawers

Drawer insert type B tray set



Intended use

- For fully equipping drawers
- For underbench units with a depth of 550 mm

Technical data

Design characteristics							
Drawer width [mm]	450	545	600	845	900	1145	1200
Tray configuration	1 x single element with a 140 mm wide trough 1 x single element with a 90 mm wide trough 1 x double element with two troughs, each 80 mm wide						
Colour	White, translucent						
Surface	Grained						

Material

Drawer insert	PP plastic
Profile rail	Natural aluminium

Ordering information

For drawer width 450 mm



Drawer inserts per set	Width x depth x height [mm]	Sales unit	Order no.
2 pieces	350 x 480 x 48	1	81012701

For drawer width 545 mm



Drawer inserts per set	Width x depth x height [mm]	Sales unit	Order no.
3 pieces	445 x 480 x 48	1	81012702

For drawer width 600 mm



Drawer inserts per set	Width x depth x height [mm]	Sales unit	Order no.
4 pieces	500 x 480 x 48	1	81012703
3 pieces	500 x 480 x 48	1	81012704

For drawer width 845 mm



Drawer inserts per set	Width x depth x height [mm]	Sales unit	Order no.
5 pieces	745 x 480 x 48	1	81012705

Organising systems for drawers

Drawer inserts per set	Width x depth x height [mm]	Sales unit	Order no.
5 pieces	800 x 480 x 48	1	81012706
7 pieces	800 x 480 x 48	1	81012707
6 pieces	800 x 480 x 48	1	81012708

For drawer width 900 mm



Drawer inserts per set	Width x depth x height [mm]	Sales unit	Order no.
7 pieces	1045 x 480 x 48	1	81012709
8 pieces	1045 x 480 x 48	1	81012710

For drawer width 1145 mm



Drawer inserts per set	Width x depth x height [mm]	Sales unit	Order no.
7 pieces	1100 x 480 x 48	1	81012711
8 pieces	1100 x 480 x 48	1	81012712
10 pieces	1100 x 480 x 48	1	81012713

For drawer width 1200 mm



Scope of delivery per set

- 1 drawer insert type A with profiled rods
- 2 sealing lips

Organising systems for drawers

Separating rod for drawer
insert type B tray set

Bowl element	Sales unit	Order no.
80 mm	1	81012700
90 mm	1	81012698
140 mm	1	81012699

Drawer insert type A

Intended use

- For completely or partially equipping drawers
- Variable partitioning of drawers
- For drawers with a depth of 450 mm and 500 mm

Technical data

Design characteristics	
Equipment	Nop mat, can be fixed with adhesive pads Drawer inserts can be removed individually
Colour	Light grey

Material	
Drawer insert, nop mat	ABS plastic

Ordering information

The dimensions of the nop mat correspond to the external dimensions of the drawer insert type A. The nop mat and adhesive pads are included in the scope of delivery.

Drawer insert type A for drawer width 450 mm Width x depth x height [mm]	Drawer inserts Width x depth x height [mm]	Sales unit	Order no.
336 x 432 x 48	2 pcs. à 96 x 288 x 48 3 pcs. à 96 x 144 x 48 3 pcs. à 96 x 96 x 48	1 set	81008343

Drawer insert type A for drawer width 545 mm Width x depth x height [mm]	Drawer inserts Width x depth x height [mm]	Sales unit	Order no.
432 x 432 x 48	3 pcs. à 96 x 240 x 48 3 pcs. à 96 x 192 x 48 3 pcs. à 144 x 144 x 48	1 set	81008344

Drawer insert type A for drawer width 600 mm Width x depth x height [mm]	Drawer inserts Width x depth x height [mm]	Sales unit	Order no.
480 x 432 x 48	5 pcs. à 96 x 240 x 48 5 pcs. à 96 x 144 x 48	1 set	81008345

Drawer insert type A for drawer width 845 mm Width x depth x height [mm]	Drawer inserts Width x depth x height [mm]	Sales unit	Order no.
720 x 432 x 48	3 pcs. à 240 x 336 x 48 3 pcs. à 96 x 240 x 48	1 set	81008346

Drawer insert type A for drawer width 900 mm Width x depth x height [mm]	Drawer inserts Width x depth x height [mm]	Sales unit	Order no.
792 x 432 x 48	8 pcs. à 96 x 144 x 48 6 pcs. à 96 x 288 x 48 3 pcs. à 96 x 192 x 48	1 set	81008347



For drawer depth 450 mm



Organising systems for drawers

For drawer depth 450 mm



Drawer insert type A for drawer width 1145 mm Width x depth x height [mm]	Drawer inserts Width x depth x height [mm]	Sales unit	Order no.
960 x 432 x 48	1 pc. à 240 x 336 x 48 9 pcs. à 144 x 192 x 48 3 pcs. à 144 x 144 x 48 1 pc. à 96 x 240 x 48	1 set	81008348



Drawer insert type A for drawer width 1200 mm Width x depth x height [mm]	Drawer inserts Width x depth x height [mm]	Sales unit	Order no.
1080 x 432 x 48	6 pc. à 144 x 384 x 48 3 pcs. à 96 x 288 x 48 3 pcs. à 96 x 144 x 48	1 set	81008349

Scope of delivery

1 drawer insert type A
1 nop mat (dimensions correspond to the drawer insert type A)
4 adhesive pads

For drawer depth 500 mm



Drawer insert type A for drawer width 450 mm Width x depth x height [mm]	Drawer inserts Width x depth x height [mm]	Sales unit	Order no.
336 x 480 x 48	1 pc. à 144 x 192 x 48 3 pcs. à 96 x 192 x 48 3 pcs. à 96 x 144 x 48 4 pcs. à 96 x 96 x 48	1 set	81008350



Drawer insert type A for drawer width 545 mm Width x depth x height [mm]	Drawer inserts Width x depth x height [mm]	Sales unit	Order no.
432 x 480 x 48	1 pc. à 96 x 336 x 48 2 pcs. à 96 x 288 x 48 6 pcs. à 96 x 144 x 48 4 pcs. à 96 x 96 x 48	1 set	81008351



Drawer insert type A for drawer width 600 mm Width x depth x height [mm]	Drawer inserts Width x depth x height [mm]	Sales unit	Order no.
480 x 480 x 48	2 pcs. à 96 x 288 x 48 2 pcs. à 96 x 240 x 48 4 pcs. à 96 x 192 x 48 4 pcs. à 96 x 144 x 48	1 set	81008352



Drawer insert type A for drawer width 600 mm Width x depth x height [mm]	Drawer inserts Width x depth x height [mm]	Sales unit	Order no.
480 x 480 x 24/48	1 pc. à 240 x 336 x 48 2 pcs. à 144 x 192 x 48 1 pc. à 144 x 144 x 48 1 pc. à 144 x 192 x 24 (drawer insert with 8 partitions) 1 pc. à 96 x 192 x 24 (drawer insert with 3 partitions) 2 pcs. à 96 x 144 x 48	1 set	81006027



Drawer insert type A for drawer width 845 mm Width x depth x height [mm]	Drawer inserts Width x depth x height [mm]	Sales unit	Order no.
720 x 480 x 48	5 pcs. à 96 x 336 x 48 5 pcs. à 96 x 240 x 48 5 pcs. à 96 x 96 x 48	1 set	81008353

Organising systems for drawers

Drawer insert type A for drawer width 900 mm Width x depth x height [mm]	Drawer inserts Width x depth x height [mm]	Sales unit	Order no.
792 x 480 x 48	2 pcs. à 144 x 384 x 48 4 pcs. à 144 x 192 x 48 4 pcs. à 144 x 144 x 48 2 pcs. à 96 x 192 x 48 1 pc. à 96 x 288 x 48	1 set	81008354

For drawer depth 500 mm



Drawer insert type A for drawer width 1145 mm Width x depth x height [mm]	Drawer inserts Width x depth x height [mm]	Sales unit	Order no.
960 x 480 x 48	1 pc. à 240 x 336 x 48 1 pc. à 144 x 384 x 48 5 pcs. à 144 x 144 x 48 8 pcs. à 144 x 192 x 48	1 set	81008355



Drawer insert type A for drawer width 1200 mm Width x depth x height [mm]	Drawer inserts Width x depth x height [mm]	Sales unit	Order no.
1080 x 480 x 48	2 pcs. à 240 x 336 x 48 2 pcs. à 144 x 384 x 48 2 pcs. à 144 x 192 x 48 3 pcs. à 96 x 336 x 48 2 pcs. à 96 x 240 x 48 2 pcs. à 96 x 192 x 48	1 set	81008356



Scope of delivery

- 1 drawer insert type A
- 1 nop mat (dimensions correspond to the drawer insert type A)
- 4 adhesive pads

Organising systems for drawers

Supplementary drawer inserts type A

Design characteristics	Drawer insert Width x depth x height [mm]	Sales unit	Order no.
	96 x 192 x 24 (3 drawer inserts)	1	81007191
	144 x 192 x 24 (8 drawer inserts)	1	81007192
	96 x 96 x 48	1	80009302
	96 x 144 x 48	1	80009303
	96 x 192 x 48	1	81005193
	96 x 240 x 48	1	81007185
	96 x 288 x 48	1	80009304
	96 x 336 x 48	1	81007186
	144 x 144 x 48	1	81007187
	144 x 192 x 48	1	81007188
	144 x 384 x 48	1	81007189
	240 x 336 x 48	1	81007190

Organising systems for drawers

Storage cupboards

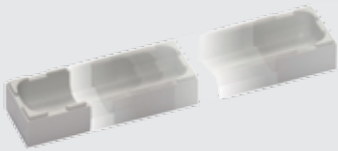
Design characteristics	Drawer insert Width x depth x height [mm]	Sales unit	Order no.
	73 x 48 x 24 Depth infinitely adjustable	1	81007194

**Supplementary drawer inserts
type A**

Scope of delivery
5 drawer inserts (drawer insert with adjustable depth: 4 drawer inserts)

Design characteristics	Width x depth x height [mm]	Sales unit	Order no.
	480 x 480 x 3 (can be cut every 24 mm)	1	81005195

Nop mat

Scope of delivery
5 nop mats

Design characteristics	Dimensions [mm]	Sales unit	Order no.
	Height 30, diameter 24	10	81007193

Location pins

Scope of delivery
10 location pins
20 screws

Design characteristics	Sales unit	Order no.
	1	81010042

Assembly set

Scope of delivery
4 adhesive pads
2 cutting aids
1 universal knife
1 assembly instructions

Organising systems for drawers

Compartment partitioning



Intended use

- Organising system for drawers

Technical data

Dimensions							
Lateral divider for drawer depth [mm]	450	545	600	845	900	1145	1200
Longitudinal divider for drawer depth [mm]	480						
Height [mm]	70						

Design characteristics							
Construction	Slot-in design Lateral and longitudinal dividers with slots						
Divider for drawer depth [mm]	450	545	600	845	900	1145	1200
Maximum number of lateral dividers	4	4	4	4	4	4	4
Maximum number of longitudinal dividers	2	3	3	5	6	8	8

Material	
Compartment partitioning	Phenolic resin

Ordering information

Basic set

For drawer depth [mm]	Sales unit	Order no.
450	1 set	81006081
545	1 set	81006082
600	1 set	81006083
845	1 set	81006084
900	1 set	81006085
1145	1 set	81006086
1200	1 set	81006087

Scope of delivery

- 2 lateral dividers for drawer depth
- 2 longitudinal dividers for drawer depth

Expansion for basic set

Length [mm]	Sales unit	Order no.	
Lateral divider	450	1	81006088
	545	1	81006089
	600	1	81006090
	845	1	81006091
	900	1	81006092
	1145	1	81006093
	1200	1	81006094
Longitudinal divider	550	1	81006741

Organising systems for drawers

Pipette tray for drawers

Intended use

- For safely storing pipettes in drawers deeper than 150 mm
- Serrated so they can be loosely inserted into drawers

Technical data

Dimensions		
For drawer width x depth [mm]	450 x 500	600 x 500
Height [mm]	40	

Design characteristics	
Fastening	For loose insertion
Colour	Grey

Material	
Pipette tray	Foamed plastic



Ordering information

The dimensions correspond to the external dimensions of the drawers.

For drawer depth [mm]	Sales unit	Order no.
450	1	81006148
600	1	81006149

Pipette holder for drawers

Intended use

- For safely storing pipettes in drawers deeper than 150 mm
- Holder for drawer depth 500 mm
- For gluing into drawers

Technical data

Dimensions	
Drawer depth [mm]	480
Height x width [mm]	70 x 50

Design characteristics	
Fastening	Self-adhesive
Colour of pipette holder	Green

Ordering information

We recommend a minimum of 2 pipette holders to equip a drawer.

Material	Sales unit	Order no.
Polyester foam, self-adhesive	1	81006147



Organising systems for drawers

Suspended file insert



Intended use

- For hanging suspended files in a drawer

Technical data

Dimensions	
Width x depth x height [mm]	350 x 350 x 245
Design characteristics	
Construction	Suitable for use with underbench units 450 mm wide and drawers with a clear height of at least 280 mm

Ordering information

Material	Sales unit	Order no.
Plastic	1	81006150

Name tag



Intended use

- For labelling doors and drawers

Technical data

Dimensions	
Width x depth x height [mm]	78 x 3 x 18
Design characteristics	
Construction	3-piece, self-adhesive, with removable paper strip for labelling

Ordering information

Material	Sales unit	Order no.
Plastic transparent	1	81008260

Waste canister for acids and alkalis

Intended use

- For the disposal of acids and alkalis

Technical data

Dimensions	
12 l, width x depth x height [mm]	195 x 231 x 350
20 l, width x depth x height [mm]	260 x 285 x 390
Connection thread [mm]	S60

Design characteristics	
Approval, canister 12 l, 20 l	UN 3H1/Y1,9 approval
Capacity [l]	12, 20

Material	
Waste canister for acids/alkalis	PE-HD

Ordering information

Capacity	Sales unit	Order no.
12 l	1	81007959
20 l	1	81007960



Waste canister for flammable liquids

Intended use

- For the disposal of flammable liquids
- Safety cabinet for storing flammable liquids according to EN 14470-1

Technical data

Dimensions	
Width x depth x height [mm]	198 x 298 x 264
Connection thread [mm]	S60

Material	
Waste canister for flammable liquids	PE-EL, electrically conductive

Ordering information

Version	Sales unit	Order no.
Canister 10 l	1	81007961
Canister 10 l For direct filling with integrated level indicator on the container	1	81007962



Canister

Funnel



Intended use

- For screwing to a container (direct filling)
- For filling acids, alkalis and flammable liquids

Technical data

Dimensions	
Diameter [mm]	140
Connection thread [mm]	S60

Material	
Funnel with hinged cover and filter	PE-EL, electrically conductive

Ordering information

Version	Sales unit	Order no.
Approval, canister 10 l, 12 l, 20 l	1	81007963



**Perfect Service
Get in touch with us!**

Complete Waldner servicing will save you time

Save yourself the time of coordinating different service providers and unnecessary external disruption to laboratory operations on different dates.

We would be pleased to provide you with an attractive offer. We would be happy to provide you with further information at any time.

Service Centre direct:

Phone +49 7522-986-225

Fax +49 7522-98679-225

service@waldner.de

An overview of the benefits:

- **One contact for all service and maintenance issues**
- **Targeted and cost-conscious by expertly planned deployment**
- **We have many years of service experience**
- **Our service fleet is equipped with genuine spare parts**
- **Service and repair of other manufacturers' equipment**

Look us up at www.waldner-lab.de for everything you need to know about our latest innovative products.

WALDNER



WALDNER Laboreinrichtungen SE & Co. KG
Mr. Yalcin Solak and Mr. Bernd Brauchle
Haidoesch 1 · 88239 Wangen im Allgaeu
Phone +49 7522 986-493 · Fax +49 7522 986-79493
zubehoer@waldner.de · www.waldner.de

WALDNER